

# **DA-58T**

**Reference Manual  
Operation of Version 1.1  
English**

---

## Preface

This manual describes the operation of the Delem control type DA-58T and is meant for operators who are instructed for operation of the total machine.

## Delem Limited warranty

- This manual does not entitle you to any rights. Delem reserves the right to change this manual without prior warning.
- All rights reserved. The copyright is held by Delem. No part of this publication may be copied or reproduced without written permission from Delem BV.

## Version history

The control software is updated regularly to increase performance and add new functionality. This manual is also updated as a result of changes in the control software. The following overview shows the relation between software and manual versions.

Software version	Manual version	Description
V1.1	V0215	first issue V1

This manual is valid for software version 1.1 and higher.

## Table of contents

<b>1. Operation overview and general introduction</b>	<b>1.1</b>
1.1. The control unit	1.1
1.2. Front control elements	1.2
1.3. USB connectors	1.3
1.4. Operation and programming modes	1.4
1.5. Getting started	1.7
1.5.1. Introduction	1.7
1.5.2. Preparations	1.7
1.5.3. Create a drawing	1.7
1.5.4. Determine bend sequence	1.8
1.5.5. Numerical program	1.9
1.5.6. The Auto menu and Manual menu, production modes	1.9
1.5.7. Back-up data, external storage	1.10
1.6. Programming aids	1.11
1.6.1. Help text	1.11
1.6.2. Listbox functionality	1.12
1.6.3. Filter, live search	1.12
1.6.4. Navigation	1.13
1.6.5. Text input and editing	1.13
1.6.6. Typing alphanumeric characters vs. special characters	1.14
1.6.7. Network	1.15
1.6.8. Keylock function	1.16
1.6.9. Manual positioning	1.18
1.6.10. Software versions	1.19
<b>2. Products, the product library</b>	<b>2.1</b>
2.1. Introduction	2.1
2.1.1. The main view	2.1
2.1.2. Product selection	2.2
2.1.3. New Product, starting a new graphical product	2.3
2.1.4. New Program, starting a numerical program	2.4
2.1.5. Edit, Copying and Deleting a product or program	2.5
2.1.6. Product Lock/Unlock	2.6
2.1.7. Filter function	2.7
2.1.8. Change directory	2.8
2.1.9. Network product selection (only available when Network option has been installed)	2.9
<b>3. Product drawing</b>	<b>3.1</b>
3.1. General product properties	3.1
3.2. 2D product drawing	3.5
3.2.1. Introduction	3.5
3.3. Line properties	3.7
3.3.1. Introduction	3.7
3.3.2. Projection	3.7
3.3.3. Precision selection	3.8
3.4. Bend properties	3.10
3.4.1. Air bend	3.10
3.4.2. Large radius: Bumping	3.11
3.4.3. Hem bends	3.13
<b>4. Tool configuration</b>	<b>4.1</b>
4.1. Introduction	4.1

---

4.2. Standard procedure .....	4.1
4.3. Tool selection .....	4.2
<b>5. Bend Sequence .....</b>	<b>5.1</b>
5.1. Introduction .....	5.1
5.1.1. Bend selector .....	5.3
5.2. Unbend product .....	5.5
5.3. Manual selection of bends .....	5.6
5.3.1. Shift gauge .....	5.7
5.4. Assignments .....	5.9
5.4.1. Introduction .....	5.9
5.4.2. Assignments - general .....	5.10
5.4.3. Assignments - Backgauge possibilities .....	5.11
5.5. Show bend sequence .....	5.14
<b>6. Product programming .....</b>	<b>6.1</b>
6.1. Introduction .....	6.1
6.2. Bend parameters .....	6.6
6.3. Bend functions .....	6.11
6.4. Special edit remarks .....	6.15
<b>7. Automatic mode .....</b>	<b>7.1</b>
7.1. Introduction .....	7.1
7.1.1. Auto mode, parameter explanation .....	7.2
Corrections .....	7.2
General corrections .....	7.3
General .....	7.3
7.2. View modes .....	7.4
7.2.1. Main .....	7.5
Bend selector .....	7.5
7.2.2. All bends .....	7.6
7.2.3. Graphical .....	7.7
7.2.4. Macro .....	7.8
7.2.5. Manual positioning .....	7.9
7.2.6. Corrections .....	7.10
Calculate corrections, programming of measured angles .....	7.11
7.2.7. Diagnostics .....	7.12
7.3. Bumping correction .....	7.13
<b>8. Manual mode .....</b>	<b>8.1</b>
8.1. Introduction .....	8.1
8.1.1. Manual mode, parameter explanation .....	8.2
Bend parameters .....	8.2
Force .....	8.3
Speed .....	8.4
Functions .....	8.4
Product Properties .....	8.4
Tools .....	8.4
Gauges .....	8.5
8.2. Programming parameters & Views .....	8.7
View .....	8.8
8.3. Macro .....	8.9
8.4. Manual movement of the axes .....	8.10
8.4.1. Movement procedure .....	8.10
8.4.2. Teach .....	8.11
8.5. Corrections .....	8.12

---

---

8.6. Diagnostics .....	8.14
8.6.1. IO status .....	8.15
Zoomed IO .....	8.16
<b>9. Settings .....</b>	<b>9.1</b>
9.1. Introduction .....	9.1
9.2. General .....	9.2
9.3. Materials .....	9.4
9.4. Backup / restore .....	9.5
9.4.1. Product backup .....	9.6
9.4.2. Product restore .....	9.7
9.4.3. Tool backup .....	9.8
9.4.4. Tool restore .....	9.9
9.4.5. Backup and restore for Tables and Settings .....	9.9
9.4.6. Directory navigation .....	9.10
9.5. Program settings .....	9.11
9.6. Default values .....	9.14
9.7. Computation settings .....	9.16
9.8. Production settings .....	9.18
9.9. Production time calculation .....	9.21
9.10. Time settings .....	9.22
9.11. Network settings (only available when Network option has been installed) .....	9.23
<b>10. Machine .....</b>	<b>10.1</b>
10.1. Introduction .....	10.1
10.2. Programming of Punches .....	10.2
10.2.1. Create a new punch .....	10.3
10.2.2. Standard punch .....	10.4
10.2.3. Hem bend punch .....	10.8
10.2.4. Air + hem bend punch .....	10.9
10.2.5. Big radius punch .....	10.11
10.3. Programming of bottom dies .....	10.12
10.3.1. Create a new die .....	10.13
10.3.2. Standard die .....	10.14
10.3.3. Hem bend die .....	10.18
10.3.4. Inside hem bend die .....	10.19
10.3.5. Air + hem bend U die .....	10.21
10.4. Machine .....	10.22
10.5. Drawing functionality for tools and machine shapes .....	10.26
10.6. Maintenance .....	10.29
10.7. System information .....	10.31
<b>A. Parameter index .....</b>	<b>A.1</b>

---

---

## 1. Operation overview and general introduction

### 1.1. The control unit

The control looks as follows:



The precise outfit of your control may vary.

Operation of the control is mainly done over the touchscreen. A description of the functions and available touch controls is given in the next sections of this manual, aside of the description of the specific functions.

This user manual focuses on the control software and related machine functions.

---

## 1.2. Front control elements

The Start and Stop button, integrated in the touch screen user interface:



Stop button + Start button

## 1.3. USB connectors



At the right side of the control a USB port is available for connection of external devices, such as a memory stick or an external keyboard or mouse.

---

## 1.4. Operation and programming modes

The DA-Touch control's main screen looks as follows:

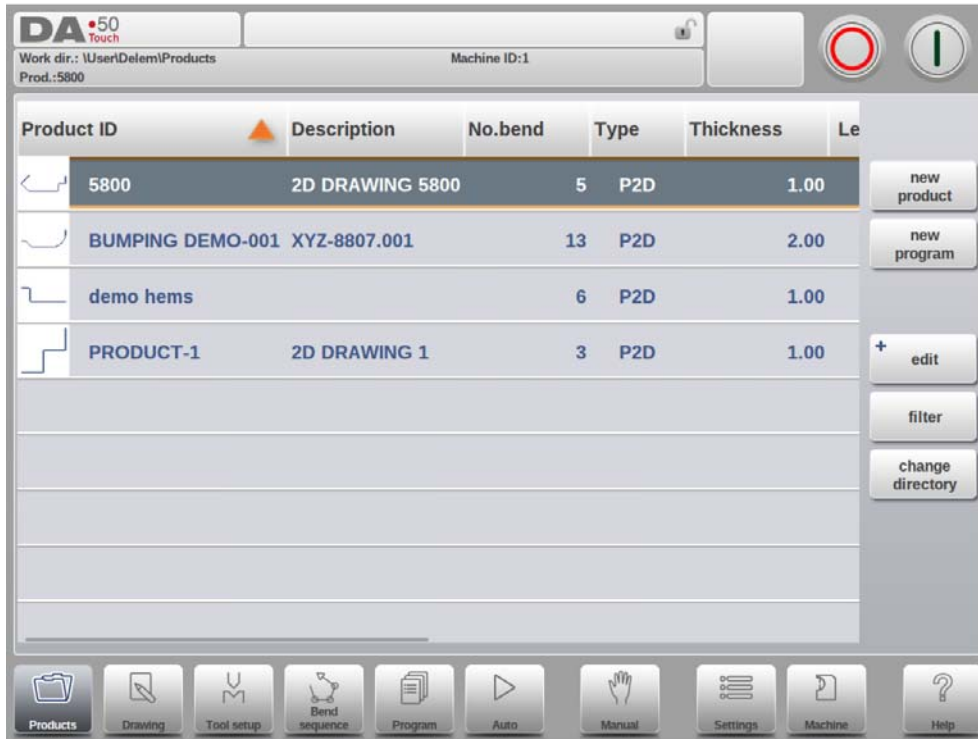

Depending on the navigation button which is active, the screen will differ. The above main screen will appear having the Products function active.

Just by tapping the various modes, the specific mode will be selected.

The structure of the main screen is as follows:

### Title panel

In the top the title panel is always shown. In this area you can find logo information, which product is loaded, the active bend, selected subdirectory and (when activated) the service row. Also machine indicators can be found here.



## Information panel

In the information panel all functions and visualisation related to the selected modus are displayed and can be found.

Product ID	Description	No.bend	Type	Thickness	Le	
5800	2D DRAWING 5800	5	P2D	1.00		new product
BUMPING DEMO-001	XYZ-8807.001	13	P2D	2.00		new program
demo hems		6	P2D	1.00		
PRODUCT-1	2D DRAWING 1	3	P2D	1.00		+ edit
						filter
						change directory

## Command panel

The command panel is part of the Information panel and is the location where the controls related to the Information panel can be found.

## Navigation panel

The Navigation panel is the area where all the major modes can be found. This area is always visible. The controls, large buttons with icons, can be used to directly switch from one mode to the other.

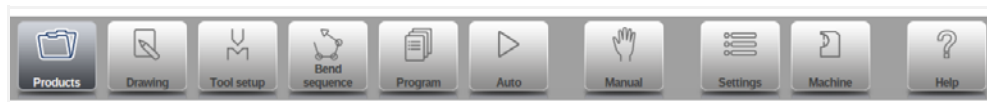

---

## Explanation of the main modes / navigation buttons



To make a new program and select a program out of the product library.



To draw/create a new product or edit an existing product (graphically).



To setup the machine and modify existing tool setups.



To compute and modify the bend sequence.



To create a new CNC-program or edit an existing CNC- program numerically.



To start production of the selected product/program.



To program all settings for making one single bend, not related to a program.



User settings and preferences applicable to the programming of new products and programs. Also the required material properties can be programmed in the Material library.



User settings and preferences applicable to the machine, tooling library including the tool editor, backup/restore of data, software version info etc.



Wherever you are in the control, via this button you can access the help system which will provide you with context sensitive information.

## 1.5. Getting started

### 1.5.1. Introduction

In order to obtain a bend program for a product, the control offers the possibility to create a product drawing and calculate a valid bend sequence for the product. With this information, a product program is generated.

This is done with the following steps:

- 1 Go to the Products mode in the navigation panel and start a new product by tapping New Product.
- 2 Enter the product properties and start to draw a 2D product profile in the Drawing mode.
- 3 Check the tooling, modify or make a new set-up in the Tool Setup mode.
- 4 Use the Bend Sequence mode to determine the bend sequence by calculating it or manually modifying it upon your own idea's.
- 5 When required modify the numerical CNC program via the Program mode.
- 6 Tap Auto and press the Start button in order to produce the programmed product.

### 1.5.2. Preparations

Before product programming can be started, the following preparations must be made.

- The correct material properties must have been programmed in the Materials library. You can find this on the Materials page in the Settings mode.
- The correct tools must be programmed in the Tool Library. Tools are necessary to create a CNC program. You can find the libraries for the different types of tools in the Machine mode.

### 1.5.3. Create a drawing

The control offers the functionality to create a drawing of the intended product. With this drawing application, tap Drawing in the navigation panel, a 2D profile is created. At this stage, there is no calculation of bends or dimensions: any profile or drawing can be created.

The drawing method on the Touch screen control is based on:

- Sketching
- Value setting

#### Sketching

The product as well as tool shape Sketching can be done by tapping on the screen in the different directions the drawing must have. The application will follow the tapping with drawing a line between the indicated points. The last point of the design will show always a big red dot.

When the drawing dot is on the screen you can hold your finger on this position and move the finger across the screen to move the connected line in another required direction or make the line length longer. This method is the so-called 'Dragging' facility. The length and angle value will be visible on the screen and can be adjusted to be exact or close to the requested value.

#### Value Setting

Once the product or tool is drawn in the Sketching method the exact values of line lengths and

---

angles can be optimized by the Value setting method. Just tap 2 times on the value of the line length or angle to change and the keyboard will pop-up. The value can be entered in 2 ways of confirmation:

- Enter function
- Enter-Next function

The Enter function will close the keyboard after entering the value. The Enter-Next function will enter the value on the line or angle to change and the keyboard will remain opened for the next programming step.

In case the typed value is erroneous, the “undo” button right from the input field can be tapped to return to the original value or the backspace key on the keyboard to delete the last typed character.

### **Zoom Function**

By pinching the screen with two fingers simultaneously one can zoom in and out on the drawing, tool or machine visualisation. By spreading fingers the system will zoom-in, by bringing fingers nearer to each other the system will zoom-out.

### **Fit-To-Screen**

In the command icons on the side of the screen you will find a Fit-To-Screen function. This can be used when the drawing size is not clear in picture. Just tap once and the complete drawing will be sized to fit the drawing screen.

### **Panning**

A single finger will enable panning.

More information about this can be found in chapter 3.

### **Features of the drawing tool**

- Graphical design of product shapes in 2D
- Scaled sheet thickness
- Auto scaling
- Horizontal and vertical projected dimensions can be entered
- Real scale tool design
- Single machine shape (pressbeam and table)
- Changing of lengths and angles
- Adding or deleting of bends
- Special bend features can be applied
  - Hemming bends can be programmed
  - Bumping bends can be used for big radius
- Existing products can be copied, changed and stored as a new product
- Closing dimension or highest precision tolerance selection
- Connecting 2D programs for 3D-production

#### **1.5.4. Determine bend sequence**

When the product drawing is completed, the control offers Tool setup mode to program the exact tool set-up as it is organised on the machine. After this you can select the Bend Sequence mode to determine and simulate the required bend sequence.

In the Bend Sequence mode, the control shows the product, the machine and the tools. In this menu the bend sequence can be programmed and checked visually. When a bend sequence has been determined, the CNC program can be generated.

More information about this can be found in chapters 4 and 5.

## **Bending sequence computation**

- Automatic computation for minimum production time
- Interactive bend sequence determination
- Manual bend sequence determination
- Collision visualization of product with tools and machine
- Free tool selection
- Assignments of turn times, backgauge speed etc.
- Blank length computation
- Production time indication
- Bending sequence simulation
- Programmable finger positions

### **1.5.5. Numerical program**

The Program menu gives access to the numerical program and values of the active product.

There are two possibilities to create a CNC program:

- enter a numerical program, started via Products mode, tap New Program, step by step;
- generate the program from the graphical bend simulation started via the Products mode, tap New Product, via the Drawing mode. (see: Drawing mode; product drawing).

If the program is entered by hand, there is no collision check. All program values must be entered manually. The program depends on operator experience.

If the program is generated from a graphical bend sequence, the program can be visualised during production. A generated program can be edited according to operation needs.

More information about this can be found in chapter 6.

When a drawing has been completed with a bend sequence, and the program is stored, the program is post processed and the numerical program becomes available.

The system automatically computes :

- Necessary force
- Machine adjustments such as:
  - Y-axis position
  - Decompression
  - X-axis position
  - X-axis retract
  - Y-opening
  - R-axes
  - Z-axes

Axes positions are calculated according to the machine configuration.

### **1.5.6. The Auto menu and Manual menu, production modes**

A product program can be executed via the Auto mode. In Automatic mode, a complete program can be executed bend after bend. In the Auto mode the Step mode can be selected to have each bend started separately.

The Manual mode of the control is an independent production mode. In this mode, one bend can be programmed and executed. It is typically used to test the behaviour of the bend

---

system.

More information about this can be found in chapters 7 and 8.

### **1.5.7. Back-up data, external storage**

Both product and tool files can be stored externally. Depending on the configuration, these files can be stored on a network or on a USB stick. This facilitates a back-up of important data and the possibility to exchange files between Delem controls.

More information about this can be found in chapter 9.

## 1.6. Programming aids

### 1.6.1. Help text

This control is equipped with an on-line Help function. When the Help-button in the navigation panel is pressed context sensitive help will be provided.

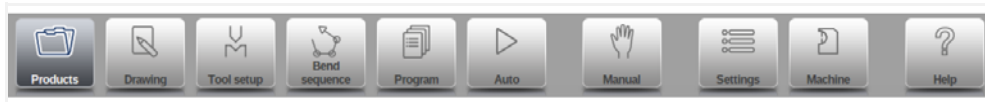

To activate a help window for a parameter tap the Help button in the navigation panel.

A pop-up window appears with information on the active parameter.

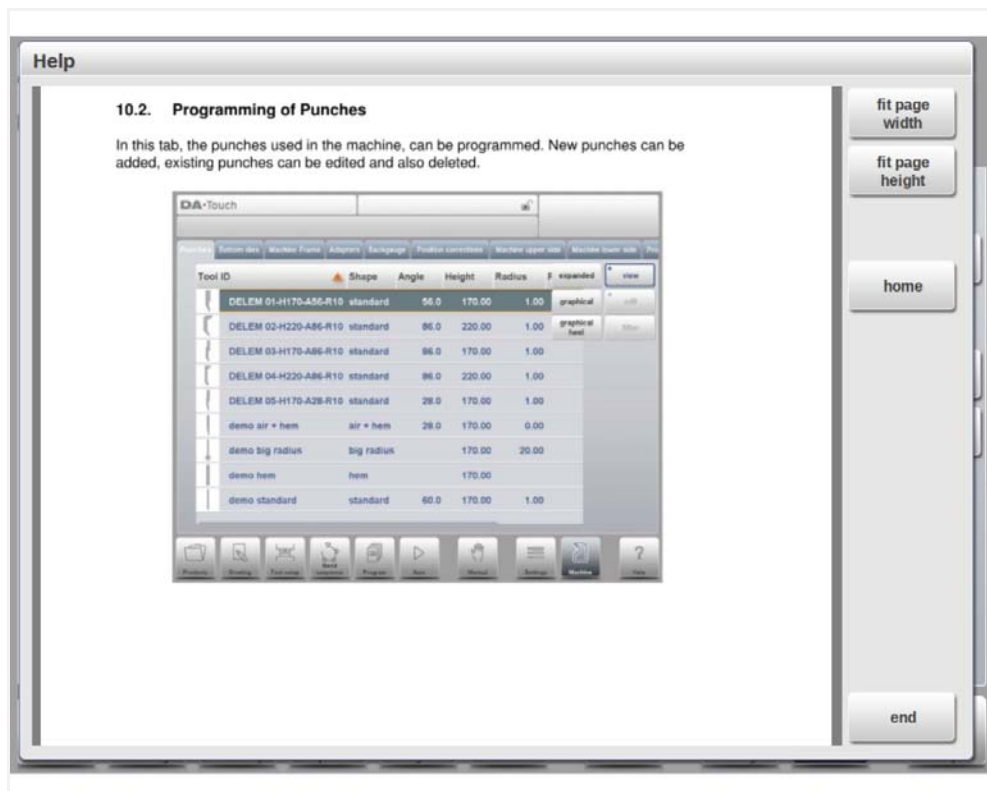

This Help window contains the same information as the Operation manual.

The help window can be used as follows:

You can scroll through the text sliding one finger in the desired direction. By tapping on the lower or upper part of the screen Previous Page / Next Page can be used to browse through the help text.

The Index function helps to jump to the table of contents. Hyperlinks in the table help to directly navigate to the desired topic.

Tap End to close the Help window.

---

### 1.6.2. Listbox functionality

Several parameters on the control have a limited number of possible values. When selecting such a parameter, by tapping the parameter line on the screen, the list of options will open up near the position where you tapped the line, and the desired value can be selected.

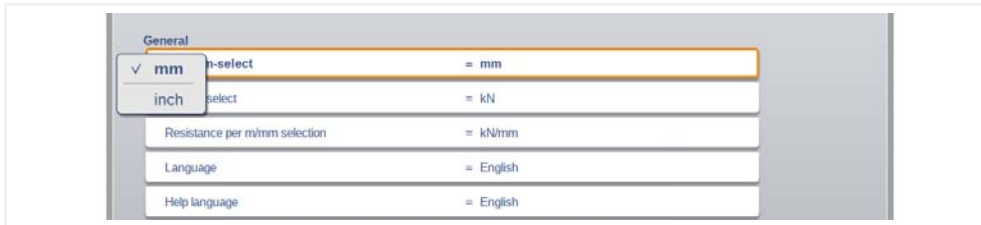

To undo the selection and the opened listbox, tapping outside the box will make it close without changing the selected parameter.

### 1.6.3. Filter, live search

In some modes a list of entities is offered (products, tools, materials, etc.). An example of such a menu is the Products mode (product selection). To search a particular product or tool, the filter function can be used. Press the command button Filter, type a part of the ID in the enter field. Automatically, the list is limited to those items that contain the typed part. Multiple search parts can be separated by <space>.

Example of a product list:	type:	shown list:
product123 product456 exampleproduct01 exampleproduct02	1	product123 exampleproduct01
	ex	exampleproduct01 exampleproduct02
	ex 1	exampleproduct01

To close an open filter screen use the keyboard-close button on the right side next to the keyboard.

## 1.6.4. Navigation

Within some modes, the program screens are divided into tabs.

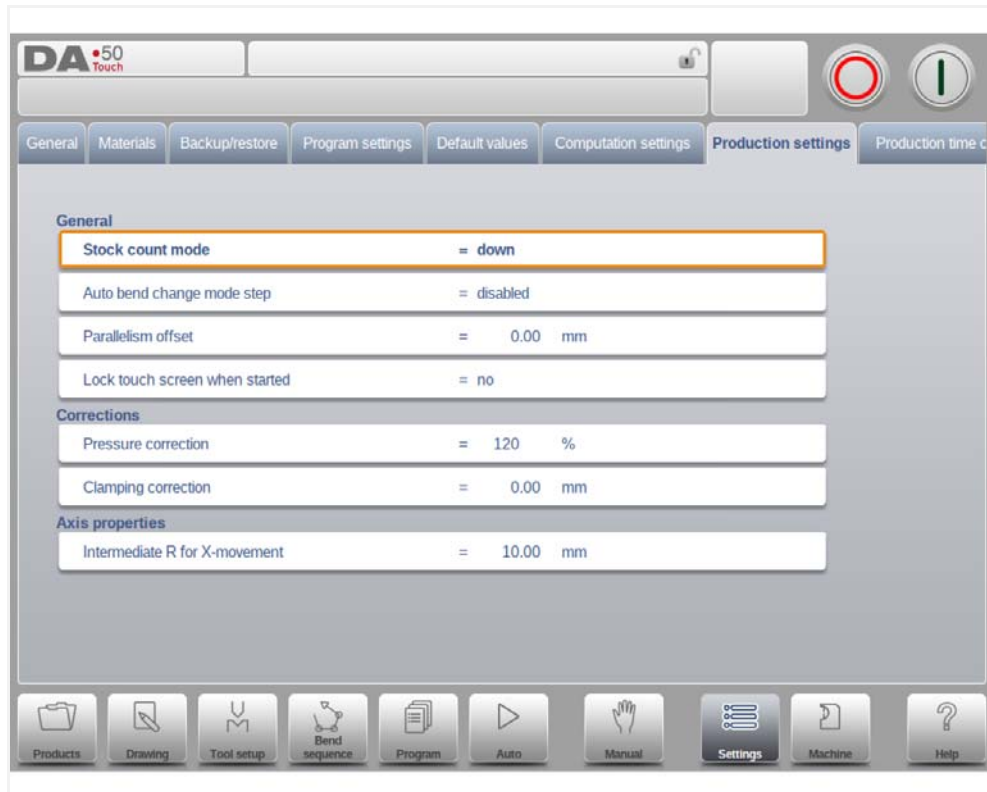

The tabs can easily be selected by just tapping them. When a tab is not completely visible or not visible at all, just by dragging the tab row horizontally, the desired tab can be "pulled" in sight and be selected.

## 1.6.5. Text input and editing

The cursor can be used to enter a specific value or text within an existing input. Just tap at the desired position to do so. The cursor will appear and input will be added there.

---

## 1.6.6. Typing alphanumeric characters vs. special characters

Both alphanumeric characters and special characters can be used throughout the control. A full on-screen alphanumeric keyboard will pop up when required. When editing a field which is pure numeric, the alphanumeric characters will be "greyed-out" and only the numerical keypad can be used. For fields which enable to use alphanumeric strings, the keyboard is completely available. Special characters as ? % - can be found using the special character button on the left-lower side of the keyboard.

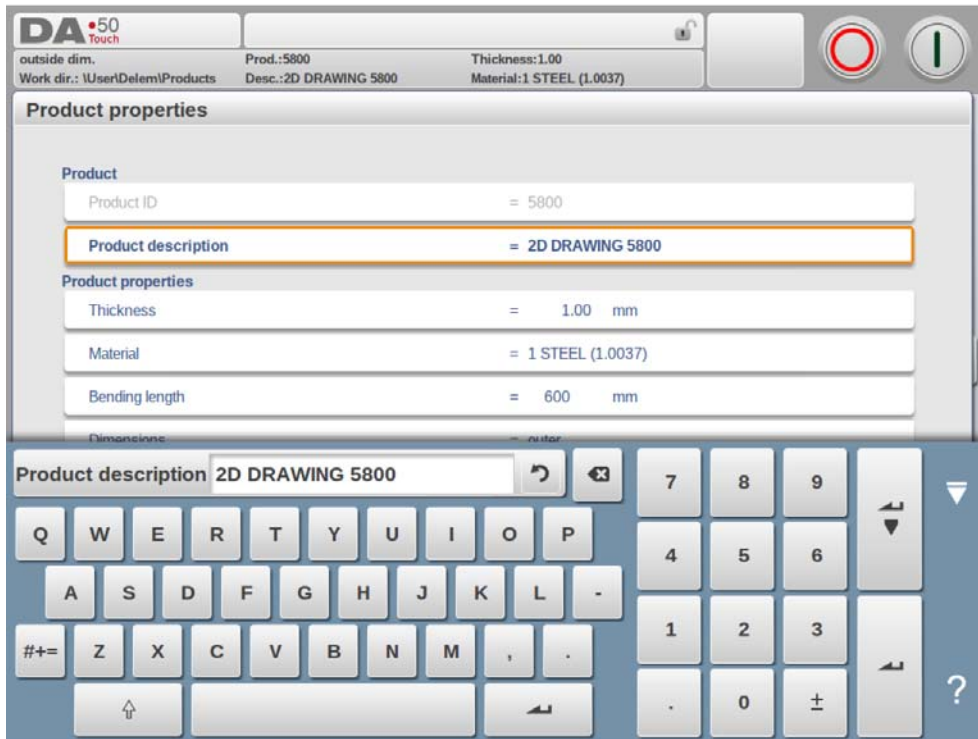

Special characters (like á, à, â, ã, ä, å, æ) are supported by the on screen keyboard by keeping a character (like 'a') pressed.



## 1.6.7. Network

The CNC control optionally can be equipped with a network interface. The network function offers the operators the possibility to import product files directly from the network directories or to export the finished product files to the required network directory.

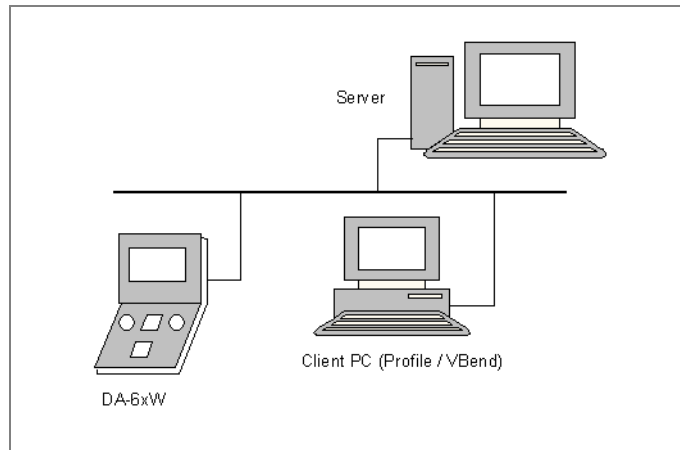

Chapter 9 about backup/restore in Settings mode contains more information about networking possibilities.

---

### 1.6.8. Keylock function

To prevent for changes to products or programs, the keylock function offers the possibility to lock the control.

There are two levels of locking the control. Program Lock and Machine Lock.

- In Program Lock, only a product can be selected and executed in Automatic mode.
- In Machine Lock, the machine is locked and the control can not be used.

To lock a control just tap the lock symbol in the top of the screen. Depending on the code which is used, the control will be in Program Lock or Machine Lock. Program Lock will show a closed lock in grey. Machine lock will show the same lock but colored (red).

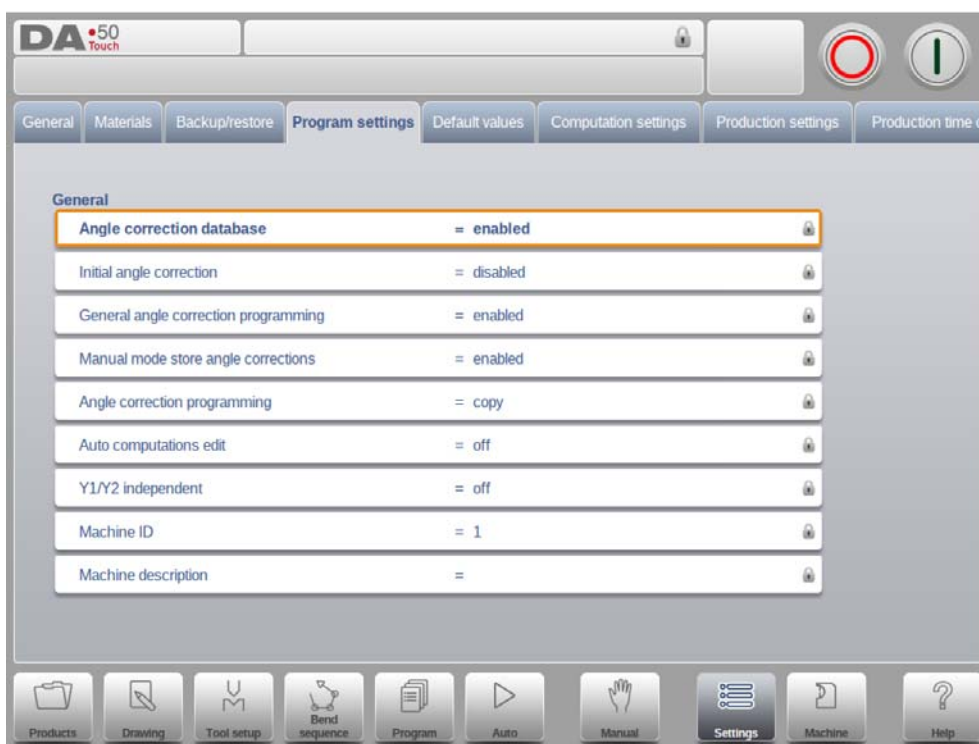

Lock symbols when Program Lock is active will also appear behind parameters to show the lock is active and modification is not possible.

To unlock the control, tap the lock symbol and enter the appropriate code. After entering, the lock symbol will show it is unlocked and the lock symbols behind parameters will disappear.

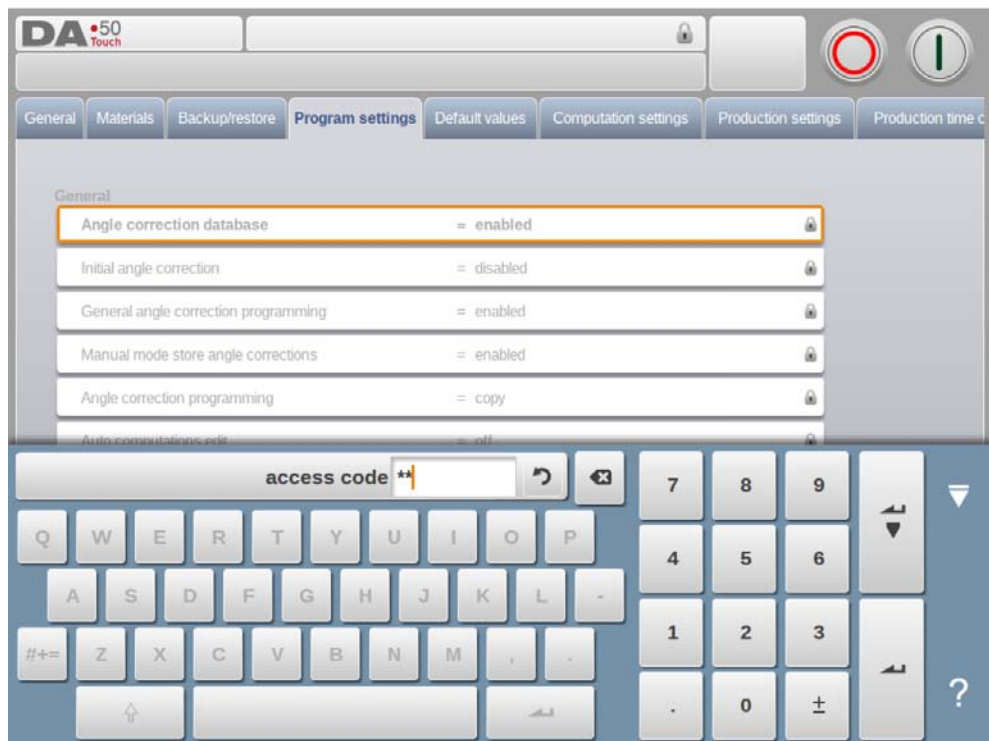

Codes can be changed upon desire. The procedure to manages codes can be found in the Installation manual.

---

### 1.6.9. Manual positioning

On the manual positioning page in Manual mode and Automatic mode a slider at the bottom of the screen can be used to position the axis. The distance moved with the slider determines the speed of the axis. When the slider is released, the axis stops. The buttons at each end of the slider can be used to fine-tune the axis position. When "sliding" the beeper gives feedback that the axis is moving.

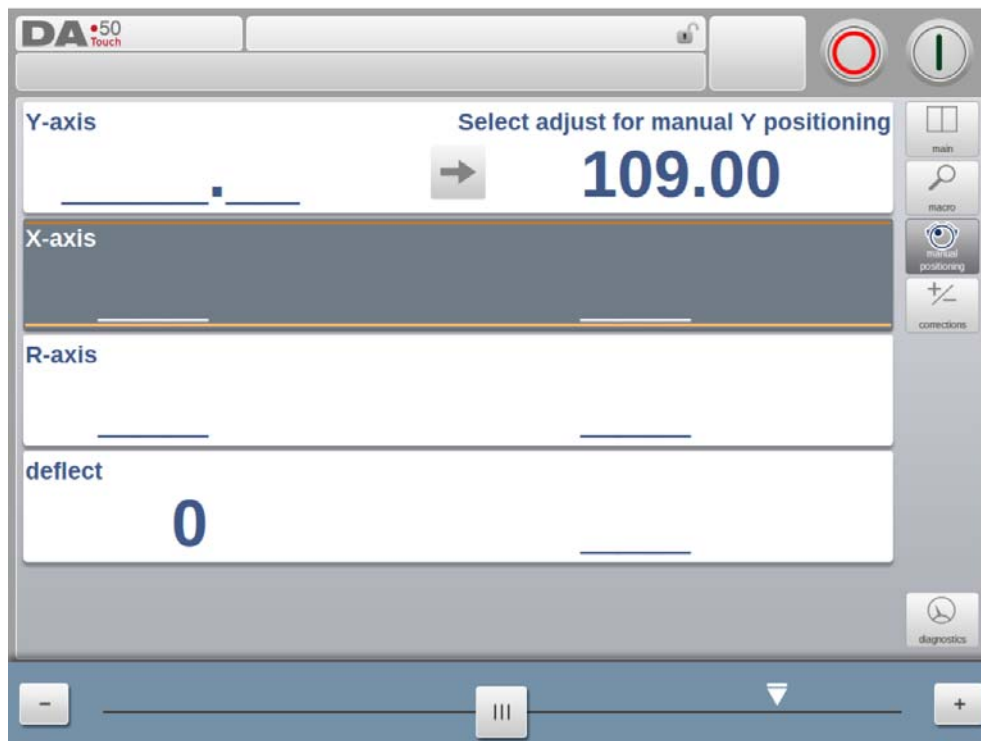

## 1.6.10. Software versions

The version of the software in your control is displayed at the System Information tab in the Machine menu.

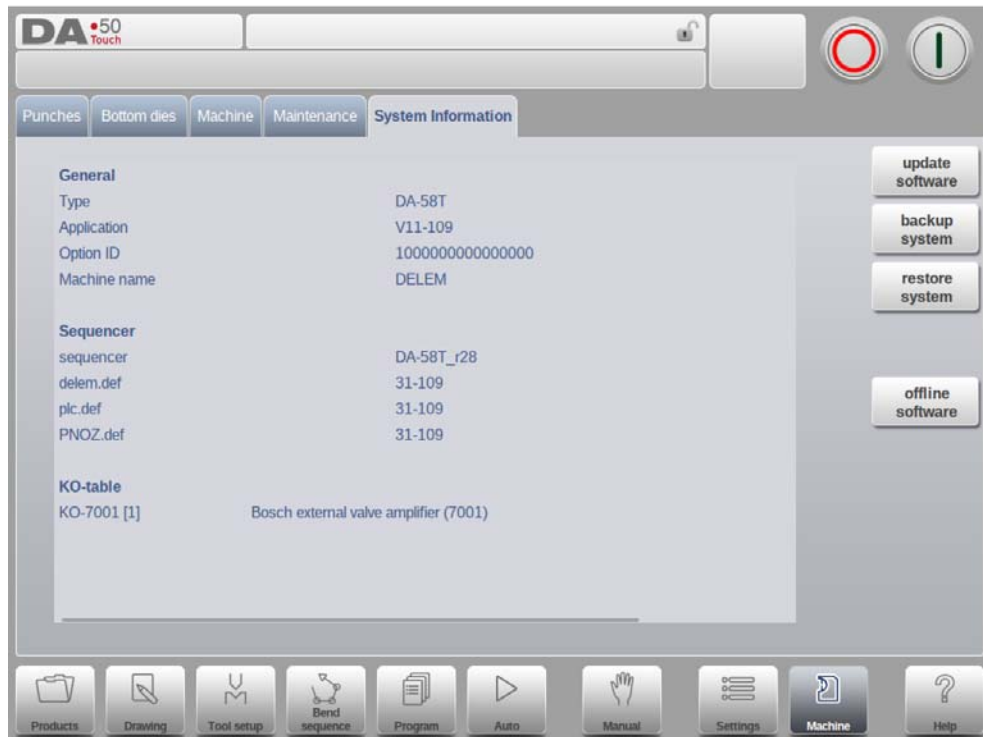

Example of version number:

V 1.2.3

V stands for version

V 1.x.x is the major version number

V x.2.x is the minor version number

V x.x.3 is the update version number

The major version number is increased when new major features are added to the software. These software changes require additional introduction and could change the normal working order. The minor version number is increased when new features and enhancements are integrated which do not change the working order. The update version number solely is used for software changes when corrections are needed in the existing software version.

---

## 2. Products, the product library

### 2.1. Introduction



In the **Products mode** existing, previously produced, products can be selected to start production or for modification in order to make a similar product. To start making a new product or program New Product or New Program can be used from this mode.

#### 2.1.1. The main view

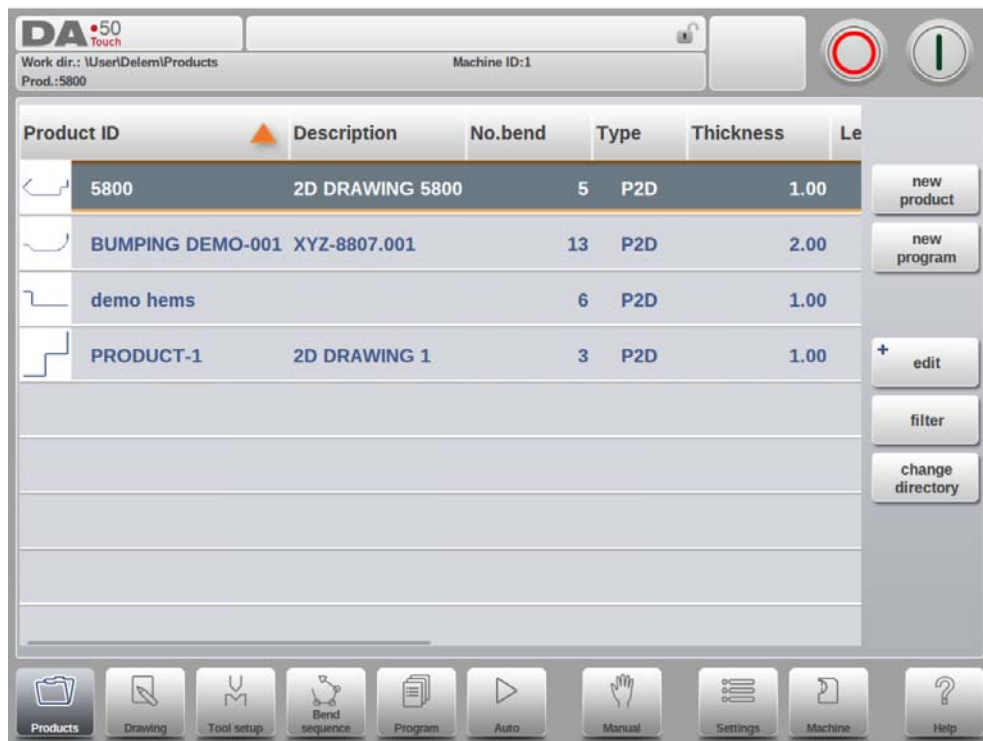

In Products mode an overview is given of the program library on the control. In this mode a product program can be selected (loaded). After that a program can be modified or executed. Each item in the list consists of a thumbnail of the graphical product (for numerical programs a symbol is shown), its Product ID, the Product Description, the Number of bends in the product, what kind of product it is (Type) and the Date it was last used or modified. The Type indication of the product shows following types of products:

- P--** the product has a CNC program, there is no drawing
- 2D** the product consists of a 2D drawing, there is no CNC program
- P2D** the product has a 2D drawing and a CNC program

If a product program is already active its ID is shown in the top of the screen. A program can be loaded by tapping the product ID or any other part of the product's line.

When there are more products than can be visualised in the screen simply drag the list in the upward direction until the product is visible. From then again a single tap on the product selects the product and activates it in the control.

### 2.1.2. Product selection

To select a product a single tap will do. The product will be selected and loaded into the memory. From here production can be started by tapping Auto. Also navigation can start through the Products Drawing (if existing), it's Tool Setup, the Bend Sequence and also into the numerical Program of the product.

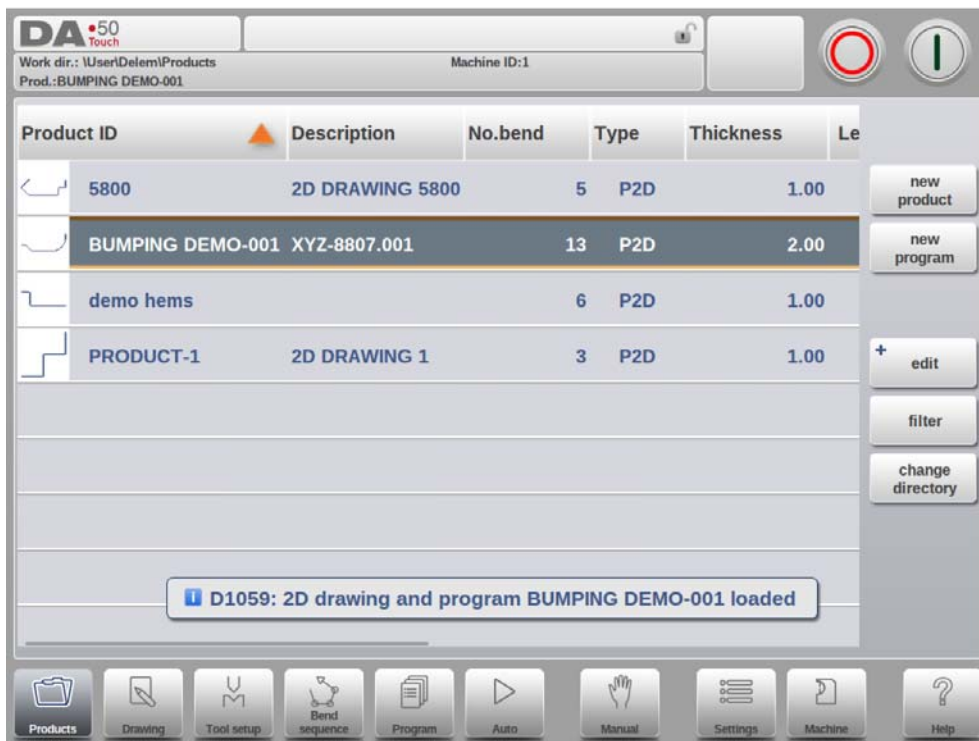

## 2.1.3. New Product, starting a new graphical product

To start a new graphical product tap New Product.

After New Product is chosen, the programming of a new product starts with its general details like Product ID, Thickness and Material.

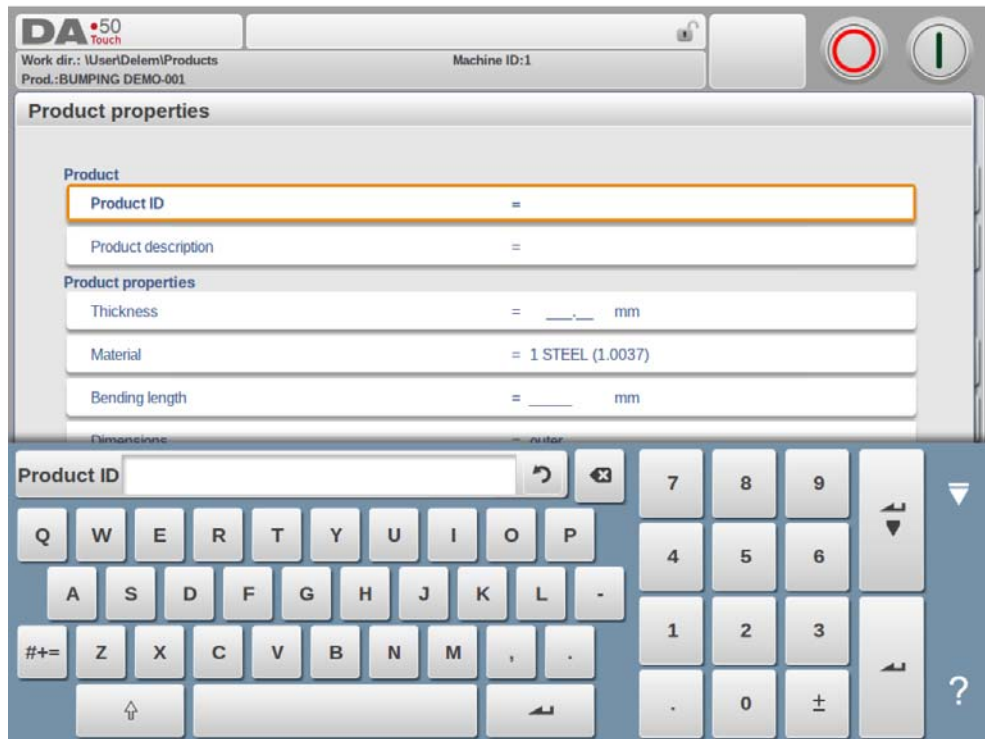

---

## 2.1.4. New Program, starting a numerical program

To start a new numerical program tap New Program.

After New Program is chosen, the programming starts with its general details like e.g. Product ID, Thickness and Material. The shown general tab is next to the successive tabs which are ready for programming the first bend.

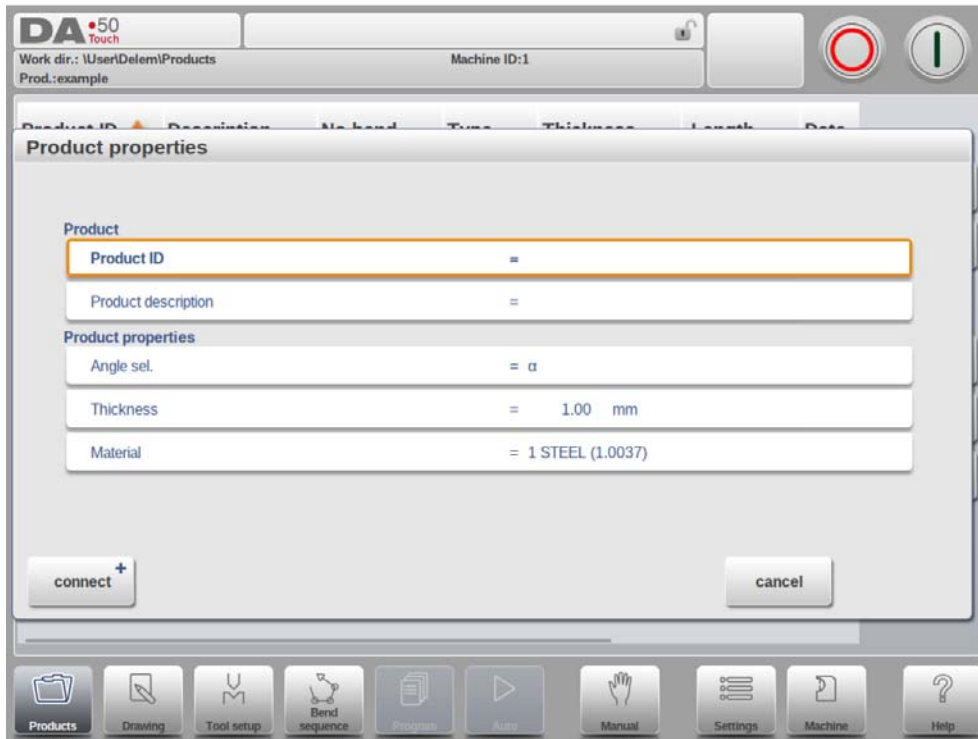

## 2.1.5. Edit, Copying and Deleting a product or program

To delete a product in the Products mode select a product by tapping it. It will be selected. After that tap Edit and use Delete. To finally delete it confirm the question. To delete all products and programs at ones, tap Delete All.

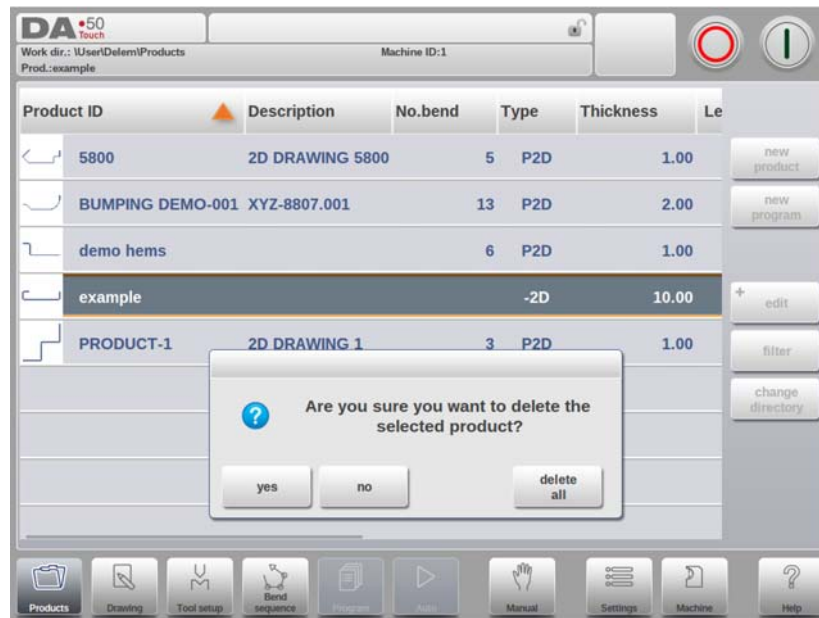

To copy a product select a product or program and tap Edit and use Copy. After this the name of the product can be programmed and the copy will be done. The product will appear in the same directory. The copied product will be an exact copy including tool setup and bend sequence if available.

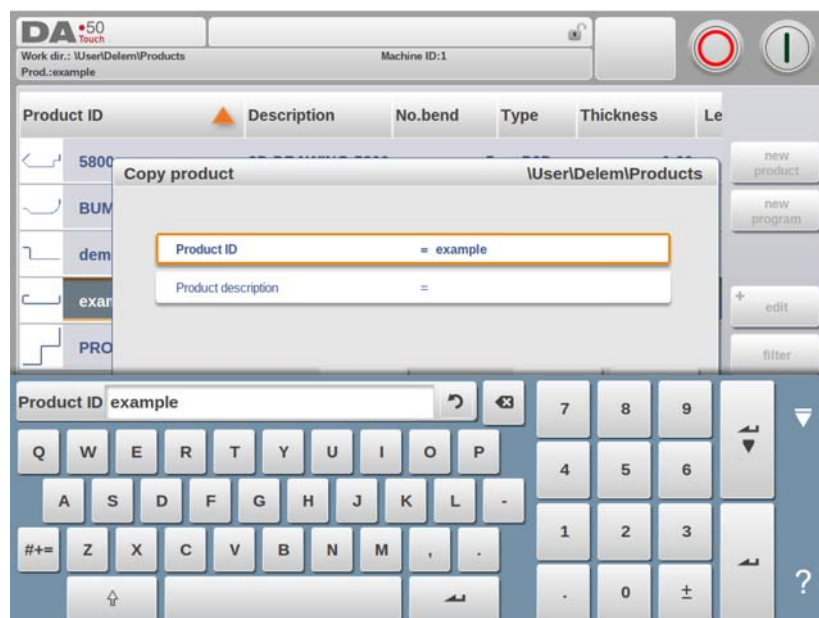

---

## 2.1.6. Product Lock/Unlock

The product Lock/Unlock function provides a simple method to prevent accidental changes to finished programs or products. In this way products which have been tuned and found to be good cannot be changed unless the product is unlocked.

When tapping on Edit the Lock Product / Unlock Product feature can be switched for each product or program.

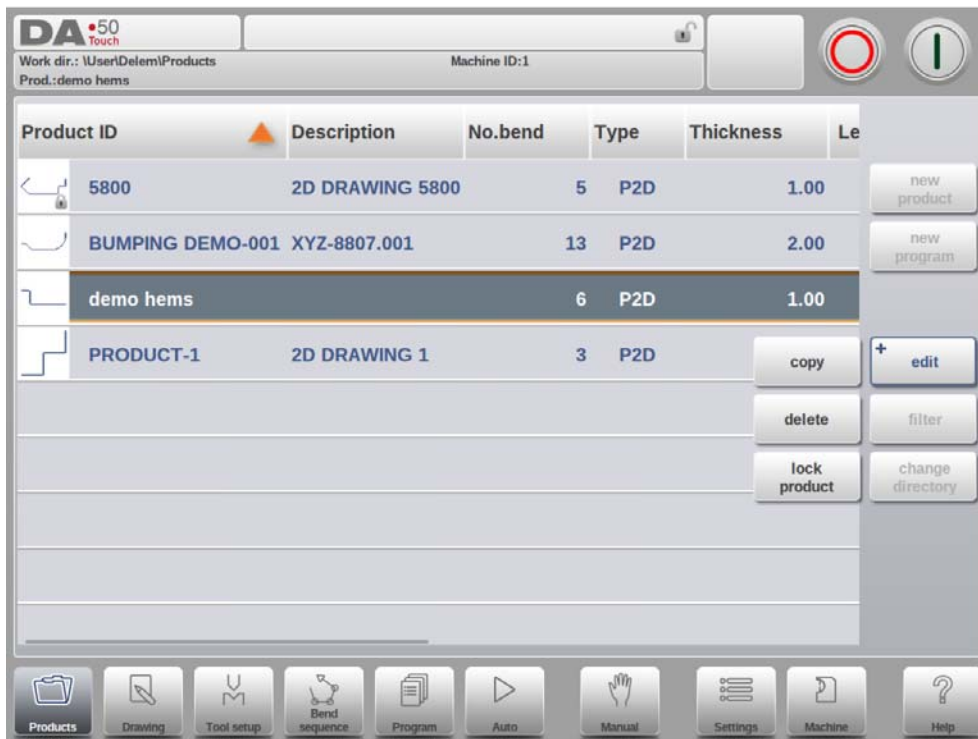

## 2.1.7. Filter function

To make finding products easier the filter function enables live searches through-out the Products mode.

When tapping Filter, the filter screen will show. By typing the desired filter string, optionally divided by spaces, the live search will start.

Optionally a different view can be selected. Also the specific property on which the filter is applied can be changed by using Selection.

Selections can be done on Product ID or Product Description.

You can either enter a complete name or number or only a part of it. If you enter part of a name and this part occurs in several product names, the control will show all product names that contain that part. It is also possible to enter a combination of name and number.

See also section 1.6.2 about Filtering and 'Live search'.

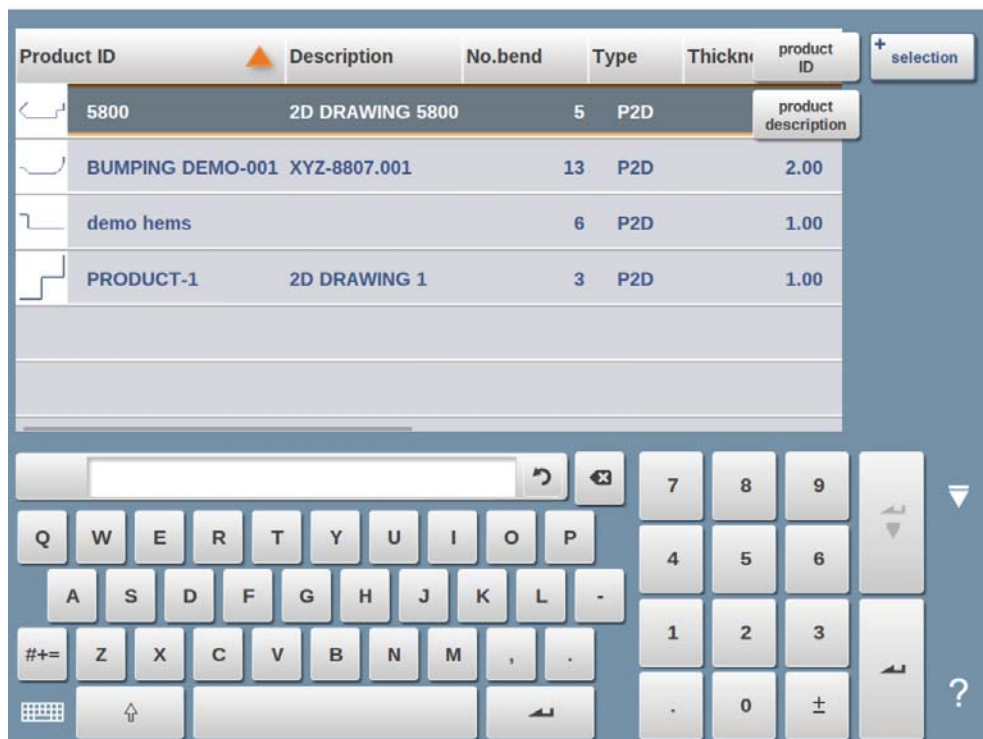

---

## 2.1.8. Change directory

To change to a different product directory, or to add a new product directory, tap Change Directory. When an obsolete directory must be removed, select the directory and tap Remove Directory. When a desired directory is reached, tap Select to jump back to the Products screen which will show all products in the directory. The active local directory name is displayed in the header.

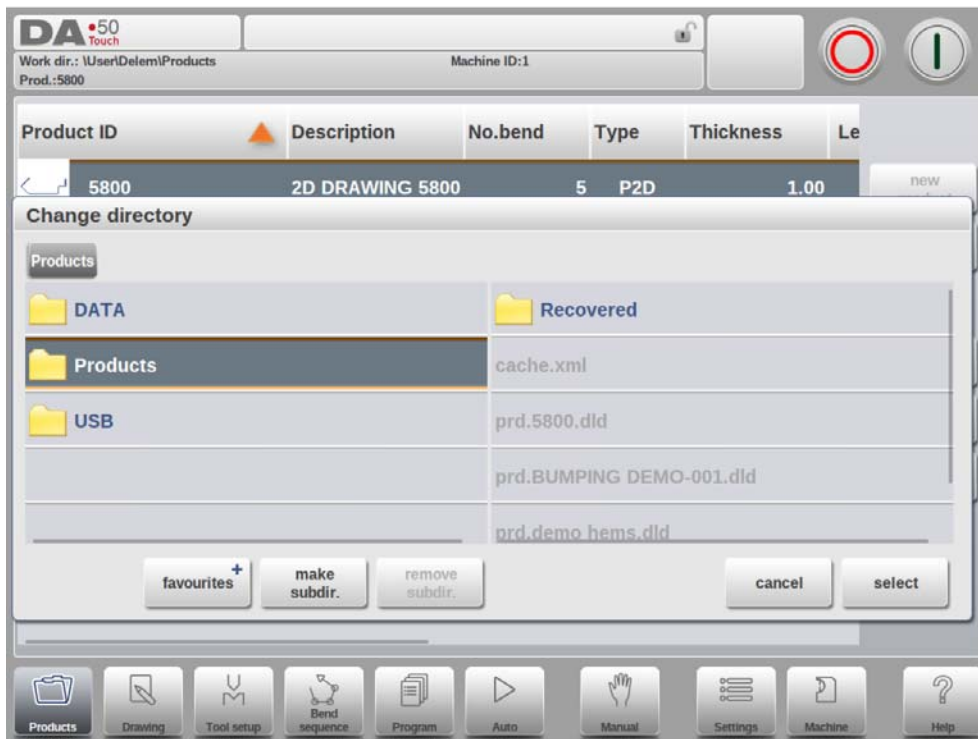

**make subdir.** Add a new subdirectory. The name of the subdirectory can be any alphanumeric string of maximal 24 characters. (Avoid the use of slashes '/').

**remove subdir.** Delete a subdirectory. If the directory contains files or subdirectories, the control will return questions to confirm the deletion for both.

In this menu it is also possible to remove existing subdirectories (only an empty one) and to make new subdirectories. Tap Make Subdir and enter the new name. Subdirectories are called subdirectories because these directories reside under the local directory 'DELEM\PRODUCTS'. The name of the subdirectory cannot be changed.

In this menu it is not possible to copy products from one subdirectory to another subdirectory; this can be done in Drawing mode or Program mode.

When you leave the product selection menu the control remembers the active subdirectory and the active product (if a product was selected) until another directory or product is selected.

## 2.1.9. Network product selection (only available when Network option has been installed)

When a network directory has been mounted in the control this mounted directory can be found under Network. Network is available next to the Product directory when using change directory. The name of the mounted drive indicates availability for product selection and storage.

The network directories can be navigated thru in the directory browser. Directories can be selected, added and removed and products can be selected. When a desired directory is reached, tap Select to jump back to the Products screen which will show all products in the directory. The network directory is now the active local directory. Its name is displayed in the header of the screen.

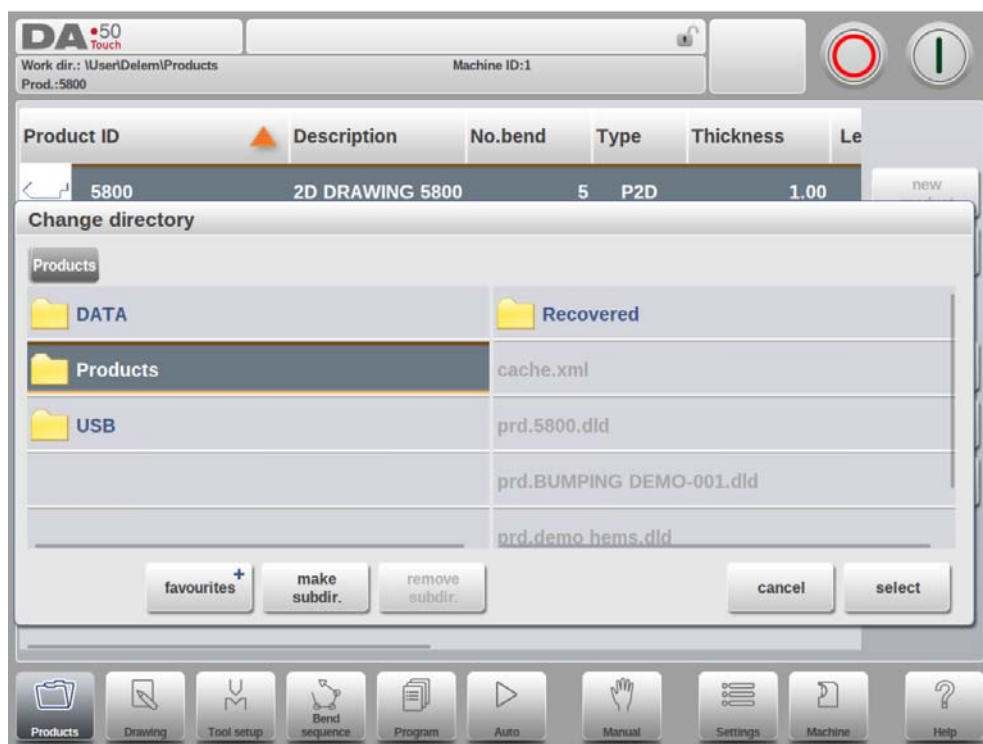

When you leave the product selection menu the control remembers the active subdirectory and the active product (if a product was selected) until another directory or product is selected.

While working with a “read-only” network, or when the network connection is interrupted, the product will be saved in subdirectory “Recovered”. This can be found as a subdirectory under Products.

---

---

## 3. Product drawing

### 3.1. General product properties

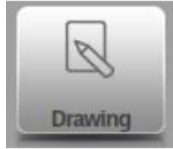

To edit an existing product drawing, choose the specific product from the Product library and select Drawing.

To start a new product drawing, choose New Product in the product library

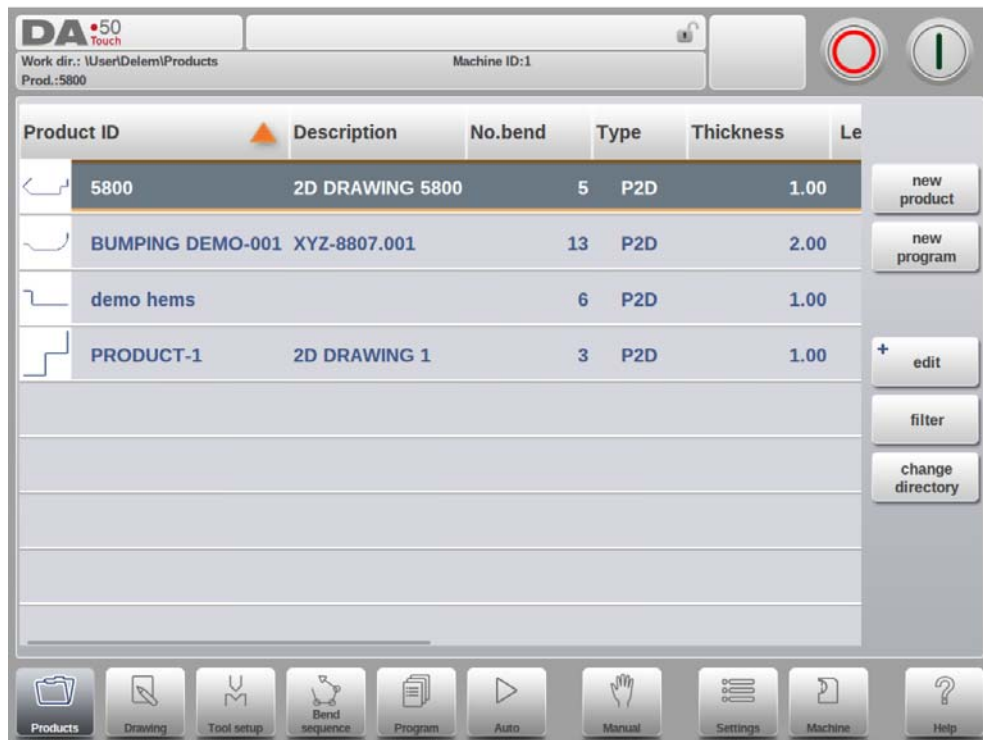

When a new product drawing is started a screen with general product properties appears. First these properties, general data, should be set before starting with the product drawing.

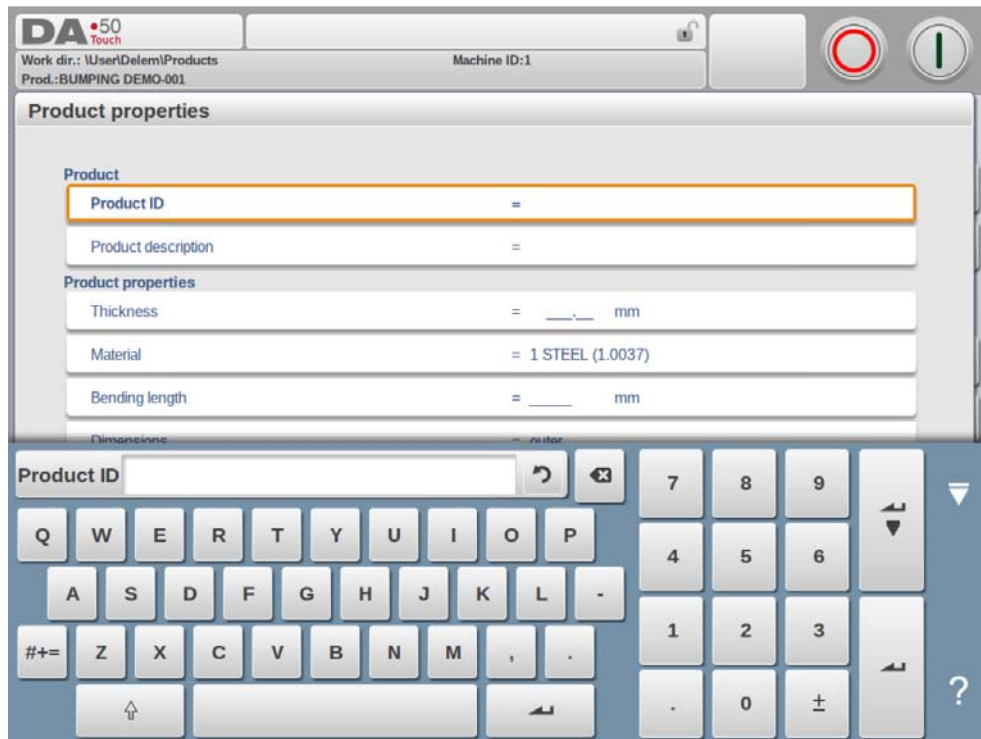

### **Product ID**

A unique name to identify a product program. The maximum length is 25 characters. The product ID may contain letters and numbers as available on the keyboard.

### **Product description**

A name or description of this program. The maximum length is 25 characters. The product description may contain letters and numbers.

If an existing product ID is entered, a warning appears that this product already exists. You are asked whether to overwrite that existing product with the new product or not. If you choose 'yes', the existing product is erased. If you choose 'no', you must enter a new ID.

### **Thickness**

Thickness of the sheet.

### **Material**

Selection of the material type of the sheet. The control contains 4 pre-programmed materials. See Settings to program materials. Press the required material to select it as active.

### **Bending length**

The Z-length of the sheet.

### **Dimensions**

Determine the use of the outside (A) or the inside (B) dimensions in the product drawing when new sides or surfaces are added. The figure below shows the definition of both the dimensions. By default this parameter has the value of the Settings mode parameter

## Default Dimensions.

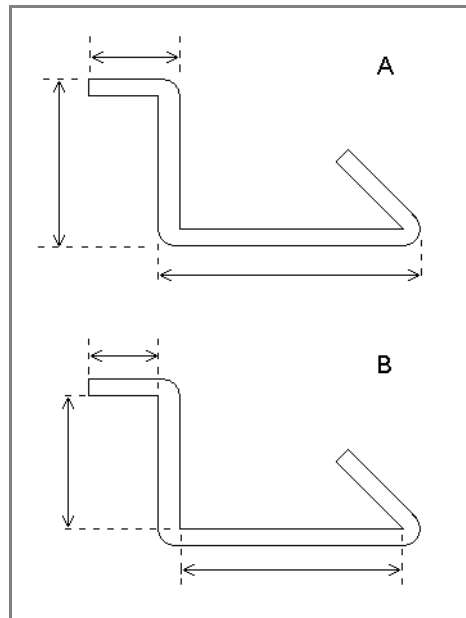

### Radius

The product radius is recalculated after selecting the tools in the tool setup, because the chosen tooling influences the resulting radius. By default this setting is 'use calculated'. With this parameter one can overrule and select 'use programmed'; in that case the product radius will not be recalculated and used as programmed.

### Bend allowance

For the bend allowance of this product you could select 'use calculated' or 'use programmed'. With 'use calculated' the bend allowance will be calculated with the Delem formula or the bend allowance table.

To change the active directory select 'Save as' and 'Change directory'. The current product is automatically copied to the new directory

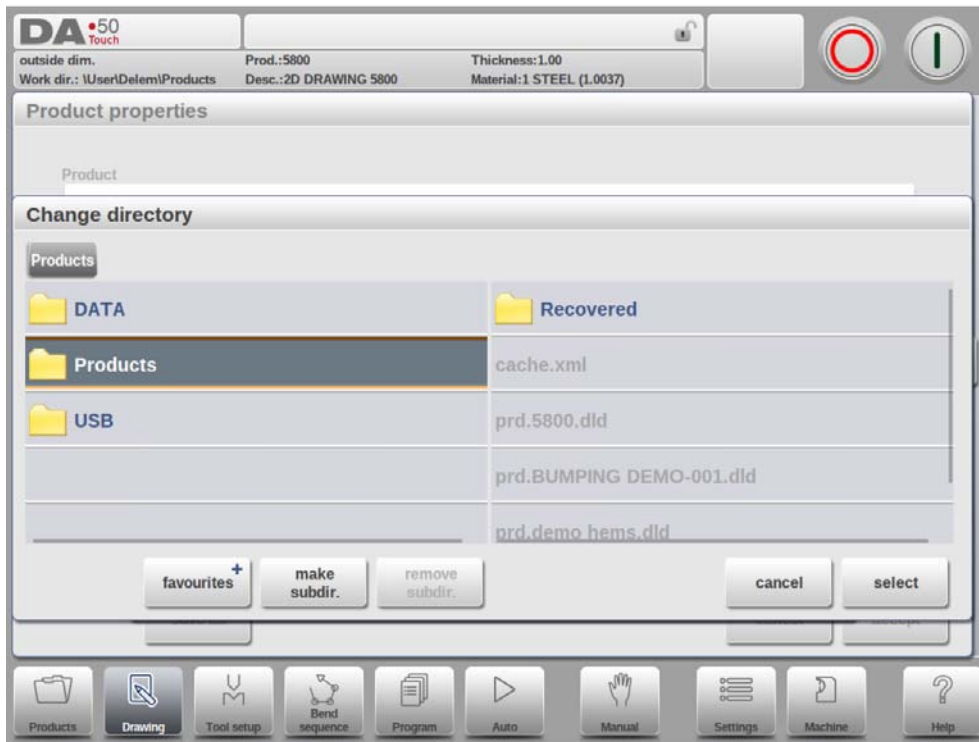

## 3.2. 2D product drawing

### 3.2.1. Introduction

After entering the general product data the drawing screen appears.

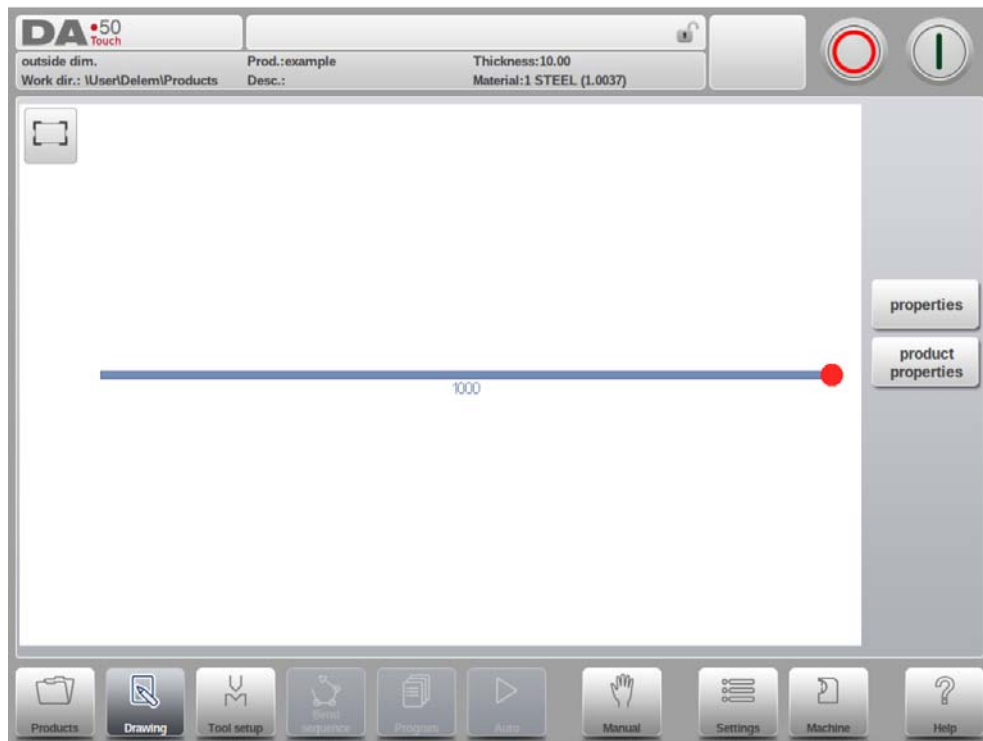

In the upper information row you will find the information about product ID, product description, inside/outside dimensions selection and actual product directory.

Now you can create the profile of the product. It is possible by using your fingers to tap and create quickly the product in 'sketch' mode. After that the real product dimensions and corresponding values can be entered by using the keyboard.

It is also possible to directly enter the angle of the bend followed by the length of that side by using the keyboard and the Enter button. The properties are prompted in the input bar of the screen on the keyboard panel. This procedure continues until the product has the desired profile.

The product data can be changed by selecting Product Properties. The properties of the product angles and lines can be changed by selecting Properties.

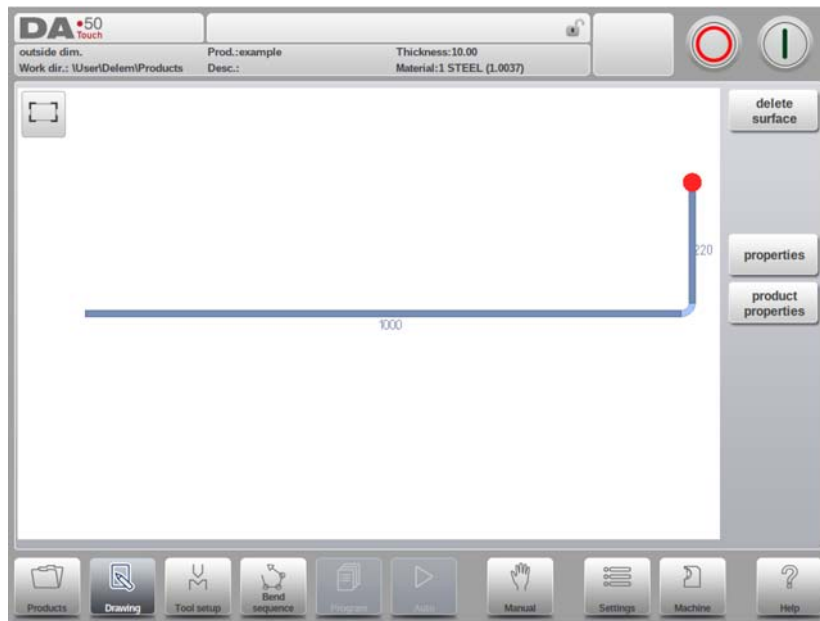

The currently active element (line or angle) is highlighted. In a product drawing you can program up to a maximum of 99 bends per product (graphical programming).

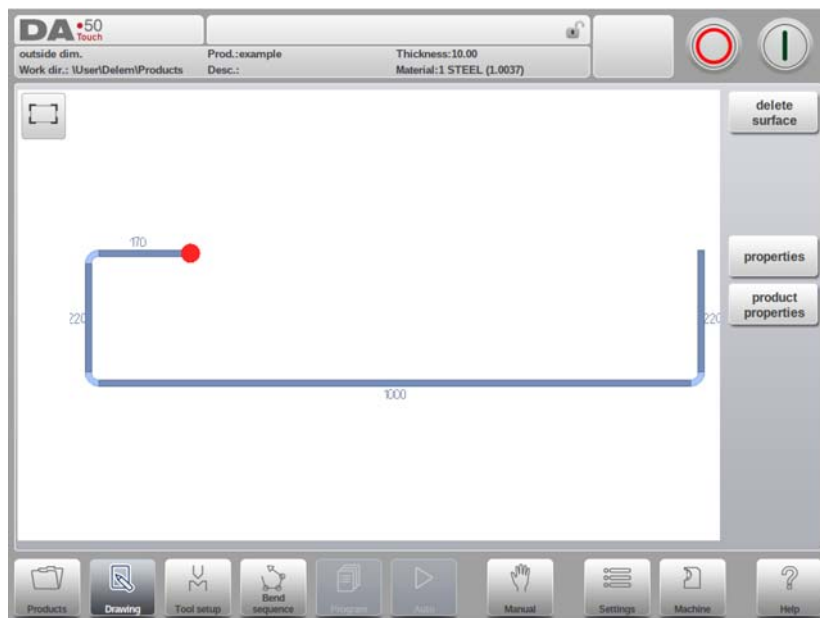

When the product drawing is finished it is possible to navigate to the next step in the programming process; to determine first the Tool Setup and after the Bend Sequence.

## 3.3. Line properties

### 3.3.1. Introduction

When the cursor is on one of the product lines it is possible to change the properties of that line by selecting Properties.

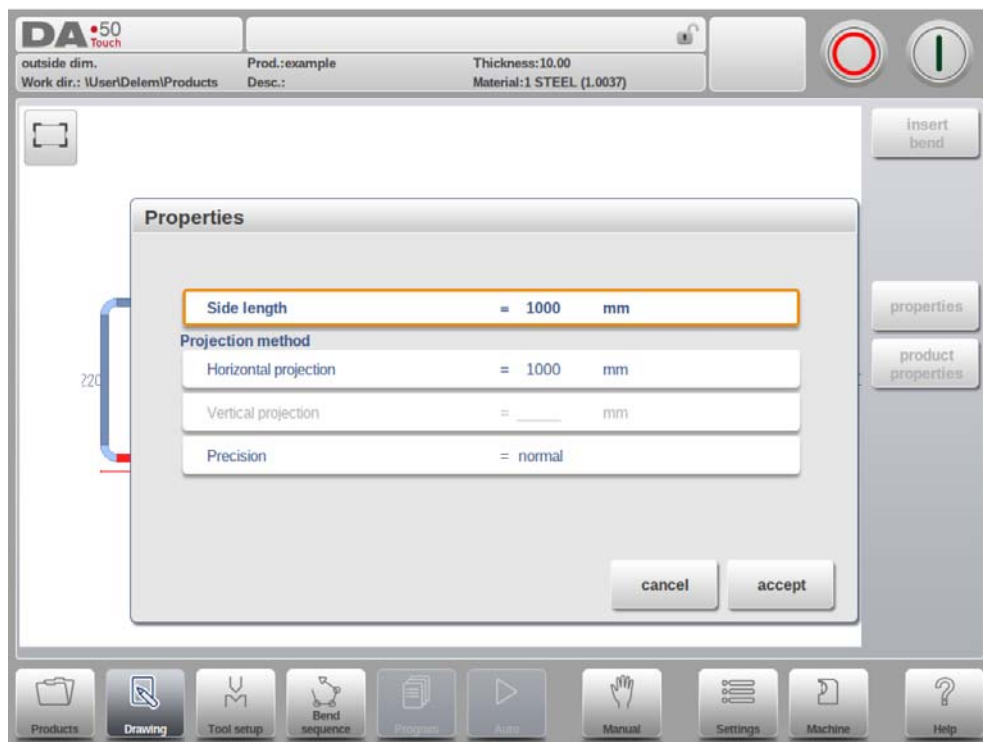

### 3.3.2. Projection

Inside the window with line properties, the following projection properties can be programmed:

#### Horizontal projection

The horizontal distance a line must measure, regardless of its angle value.

#### Vertical projection

The vertical distance a line must measure, regardless of its angle value.

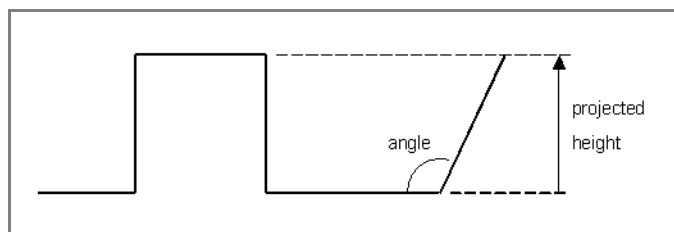

The projection function is a useful aid for drawing diagonal lines between points without having to compute the precise side length. When a line is selected, simply enter a horizontal

or vertical projection distance and press Enter. The required line length is computed and applied to the selected segment.

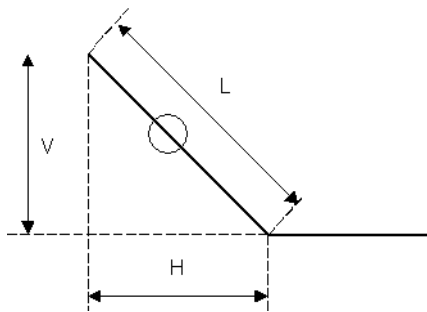

L is normal entered line length  
 V is vertical projected line length  
 H is horizontal projected line length

It will be noted on the screen if projection is not possible.

### 3.3.3. Precision selection

When the drawing cursor is on a line segment, you can select the level of precision for this line. Enter the properties and go to the parameter Precision.

#### Precision

Select the level of precision for a line.

**Normal:** Achieve normal accuracy for this segment.

**High:** At bend sequence computation the back gauge stop position will be chosen to get the highest possible precision for this line interval.

**Closing dimension:** At bend sequence computation the back gauge stop position will be chosen to get the resulting tolerances in this line interval.

Example:

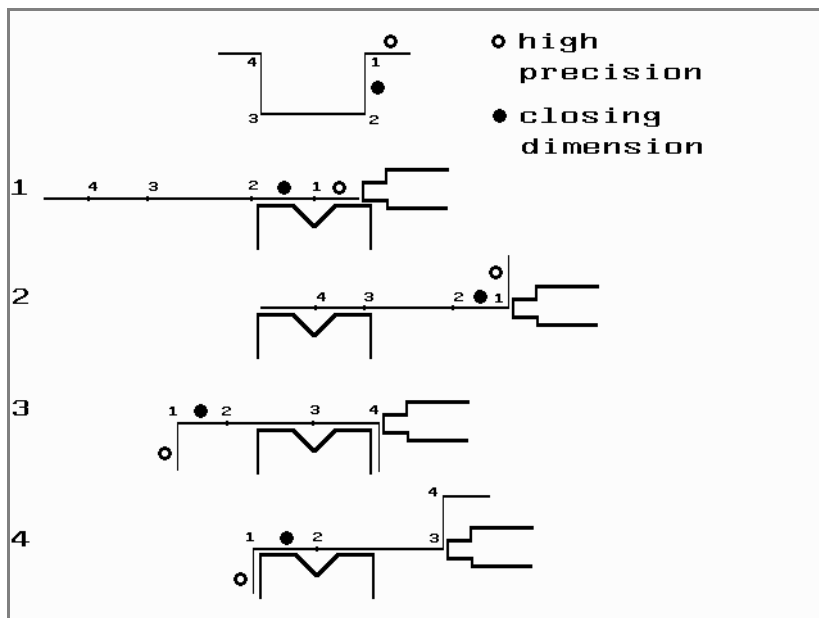

Line interval marked with the open circle should be, if possible, directly placed between back stop and the centre of the die.

## **Notes**

Specifying line intervals with high precision and closing dimensions may result in longer production time.

The precision parameter will have priority over the "front extend ratio", if that is set to "comply if possible".

---

## 3.4. Bend properties

### 3.4.1. Air bend

Drawing a product graphically is simply programming the line length, angle value, next line length, etc. till the product has its required shape. The bends in the product have their standard or specific properties. The bend properties can be set by selecting the bend and selecting Properties.

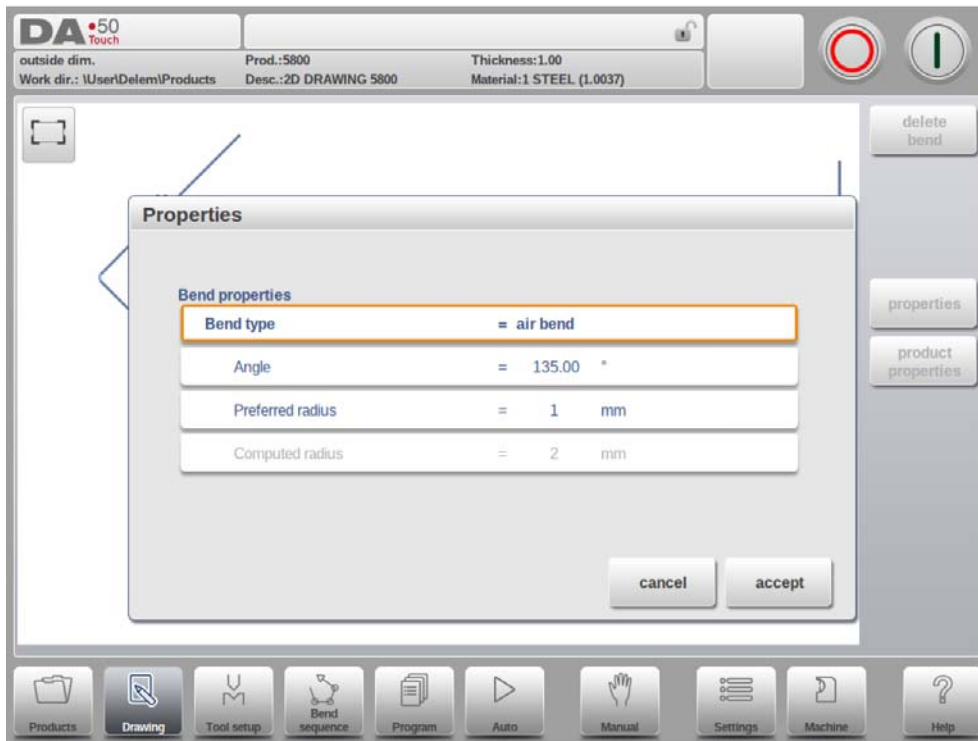

#### Bend type

With the bend type it can be determined what kind of bending process is required.

Options are:

- Air bend as normal bend with a defined angle and preferred radius.
- Bumping as bend process to realise a large radius in different steps of airbending.
- Hem bend as bend process including the pre-bend (a standard air bend with a sharp angle) and hemming action with help of a special hemming tool.

#### Angle

The angle value to bend.

#### Preferred Radius

The intended radius which is programmed. As initial value the programmed product thickness is used. This radius can also be a large radius requiring large radius tools.

#### Computed radius

The resulting radius as computed from the control settings. Amongst others the resulting radius is depending on the used tools in the bending process

A large radius is meant to be bent with a special radius punch with large radius. If such a punch is not available, the bumping method can be selected. The radius value may not exceed the length of any adjacent sides. For the definition of the line lengths to be programmed in the part connected to a radius bend, see figure below.

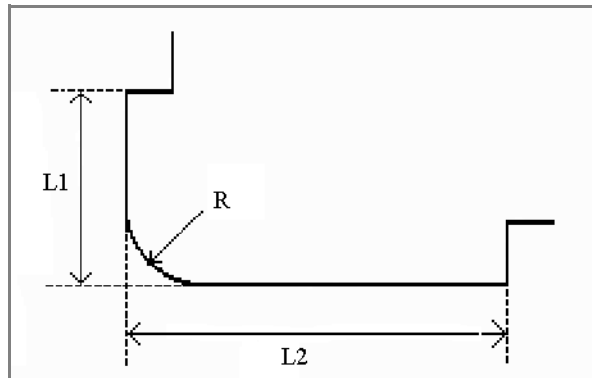

Lengths L1 and L2 must be equal or bigger than the radius R.

It is also possible to create a bend by placing the cursor on the flange end where the bend is required and select Properties. In this way the pop-up window will appear with an extra parameter to fill-out.

### 3.4.2. Large radius: Bumping

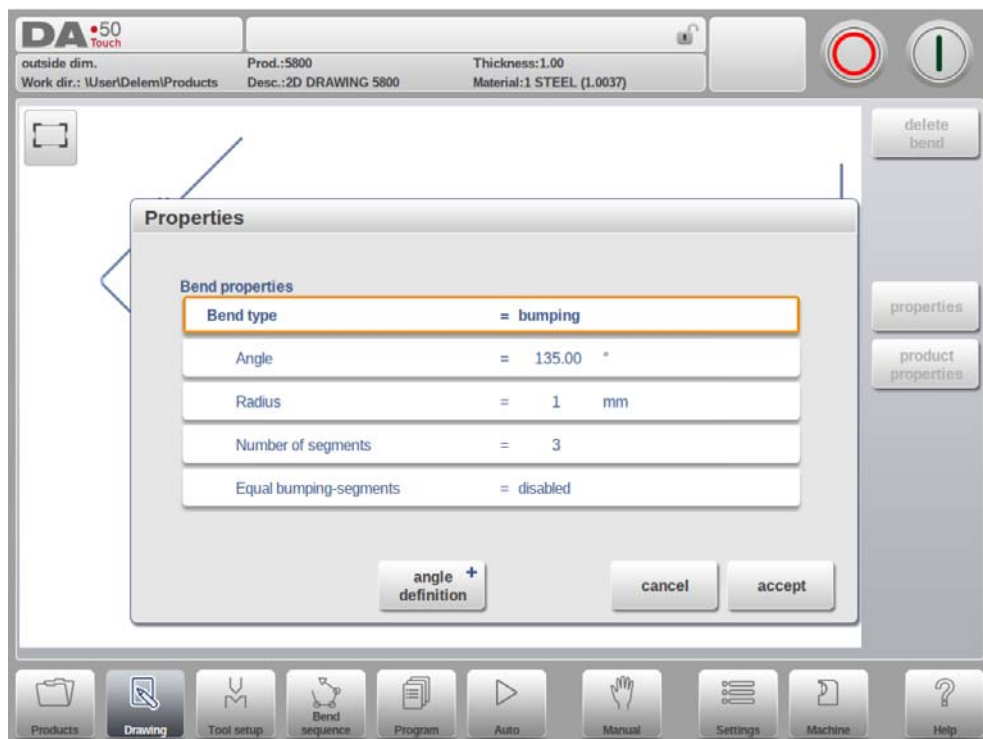

If a tool with large radius is not available, the bumping method can be chosen. With this method, a large radius in a product is obtained by a series of slight bends in succession.

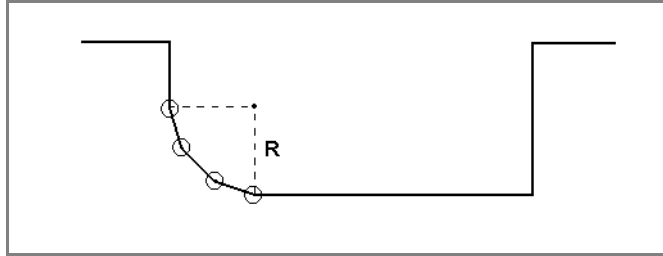

First you can choose the Angle Definition. The available definitions are:

- The default angle is the angle which could be programmed as standard.
- The central angle is the supplement of the default angle (i.e. 180 degrees - default angle).

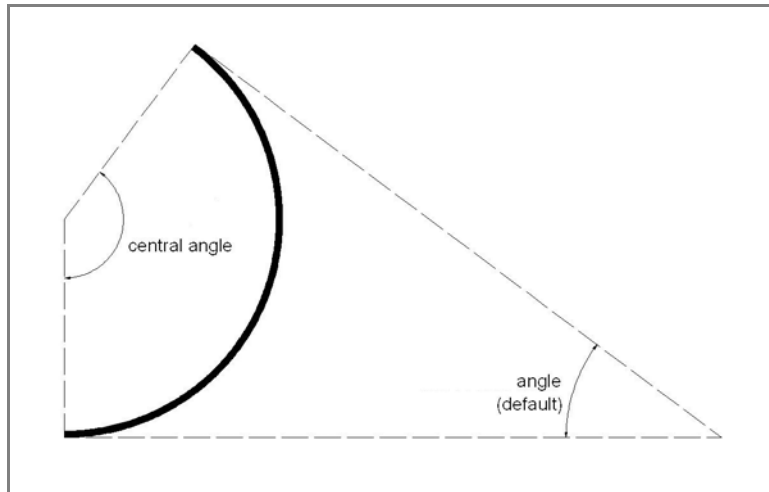

To apply the bumping method, the following parameters must be programmed:

### Central angle

The supplement of the angle value to bend.

### Radius

The intended radius which is programmed. As initial value the programmed product thickness is used.

### Number of segments

The number of segments in which the radius will be divided. The number of bends in this radius is the number of segments plus 1.

The more segments you select, the more bends will be used to create the programmed radius within a smaller tolerance. With a high number of segments you will need a smaller V-die opening to be able to bend in a proper way.

### Equal bumping-segments

When a product has a radius bend, the segment size is computed from the number of segments, which has been defined by the user. Standard the first and last segment are calculated half the size of the mid segments to obtain a better result. However, it can be a problem selecting a die suitable to bend these small segments. Therefore the control can calculate an equal size for all segments. This can be defined with this parameter.

- Disabled (no equal sizes)

- Enabled (equal sizes)

When Enabled all segments will have an equal size.

When Disabled the calculation is including half size segments. If in this case a problem with the size of the V die is detected in the bend sequence determination, the user is asked whether or not to select a re-calculation with equally sized segments.

When you must program such a bend, first program a standard angle with adjacent sides. Then put the cursor back on the angle, tap the function Properties and select Bumping as Bend Type. You will be prompted to program the radius, the number of segments and if you like to have equal bumping segments or not. After programming these parameters the radius is drawn in the product and a message will appear on the screen with information about the smallest calculated segment length. The smallest segment length has consequences for the selection of the die.

### 3.4.3. Hem bends

When creating the required profile of the product with a hem bend it is possible to first prepare a flange with a prebend angle, place the cursor on the bend and select Properties. The bend properties can be programmed in the pop-up window.

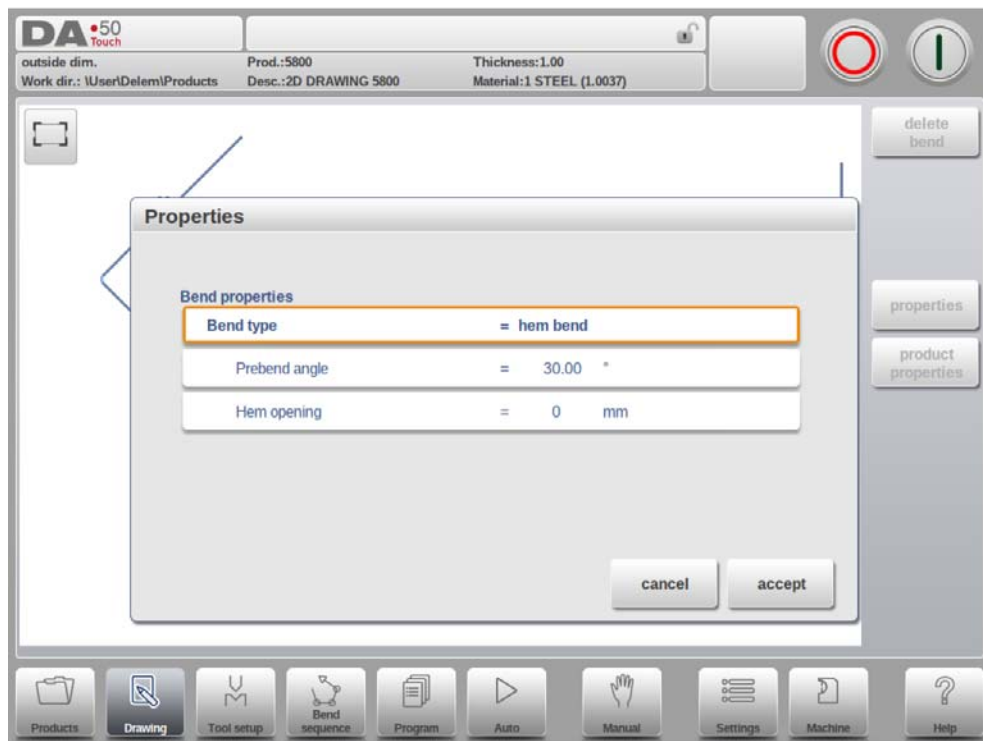

It is also possible to create a hem bend by placing the cursor on the flange end where the hem bend is required and select properties. In this way the pop-up window will appear with an extra parameter to fill-out.

### Bend properties

#### Prebend angle

The required angle of the pre-bend, normally a sharp angle. The angle can be set upon

---

the best practical value, the default value is 30 degrees.

### **Hem opening**

The hem bend can be made with a certain opening distance between the 2 flanges. The hem opening value will be used calculating the beam position in the hemming process. By default this parameter has the value of the Settings mode parameter Default Hem Opening.

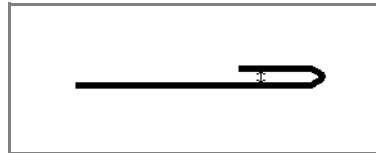

### **Side properties**

#### **Side length**

The length of the flange to hem.

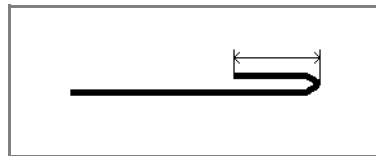

## 4. Tool configuration

### 4.1. Introduction



To edit or modify a tool setup for the product, select the product from the library and use Tool Setup

### 4.2. Standard procedure

When the function Tool Setup has been activated, the screen shows the active machine set-up. Both punch and die can be selected from the tool library.

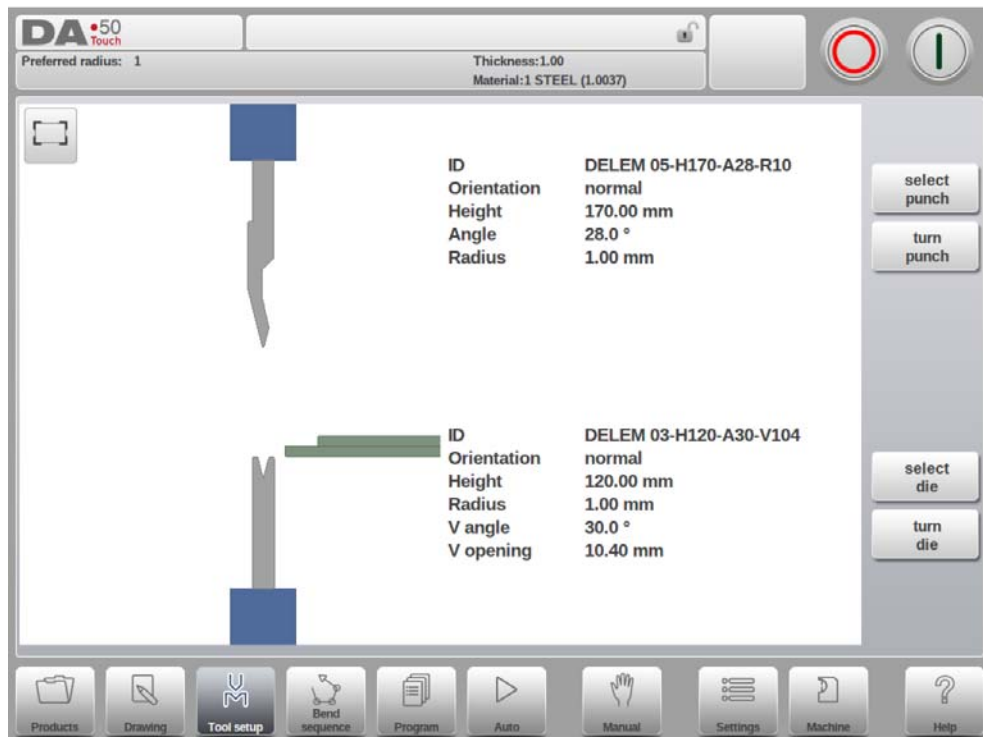

The Upper and Lower tool, resp. Punch and Die, in the machine are shown and can be changed. Tools can also be turned in this screen.

---

### 4.3. Tool selection

When selecting tools, both upper and lower tool (resp. punch and die) can be selected from the tool library.

Tap Select Punch or Select Die to change tools to the configuration.

To change the filtering, Selection can be used to switch in between ID and Description.

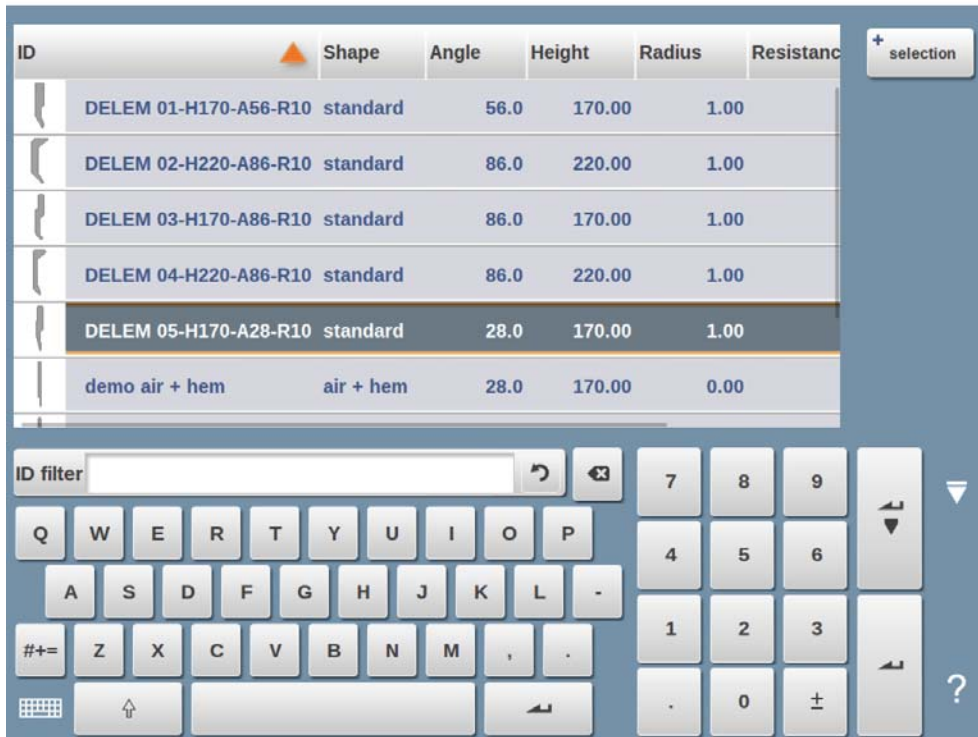

If only a part of the tool ID is typed, the control automatically offers a list of tools with the typed characters. This is a filtering function.

## 5. Bend Sequence

### 5.1. Introduction



To generate or modify a bend sequence for the product drawing, select the product from the library and use Bend Sequence

When a tool configuration is available, the bend simulation can be started to determine a bend sequence for the active product. The bend sequence determination is started by tapping the navigation button Bend Sequence.

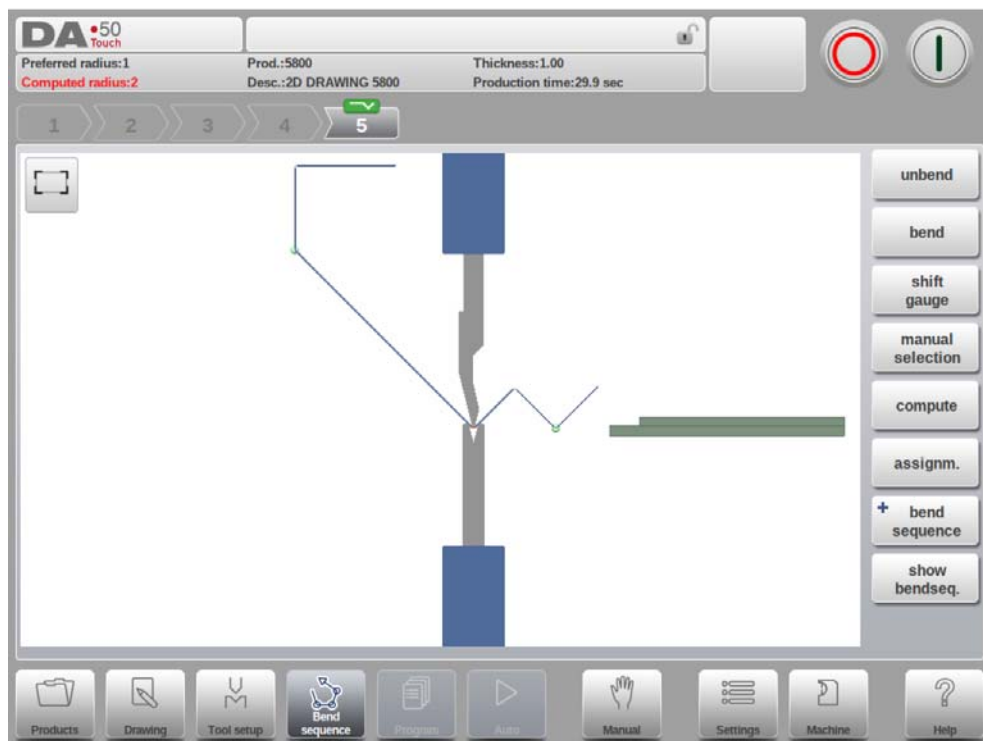

The bendsequence determination can be realised by automatic calculation starting with the bent product. It is also possible determining the sequence manually starting with the flat product, not using the automatic calculation.

In the bendsequence screen the product appears between the tools in a possible last bend position. When starting the simulation, the product is shown in its final state. In order to obtain a bend sequence, the product must be unfolded from the last bend to the first. This can be done with the available function keys.

When it is preferred to start with a unfolded product to manually chose the bendsequence, this can be chosen under the command button Bend Sequence.

---

## Functions

### Unbend

Unbend the currently shown bend or start searching for the next feasible bend to unfold.

### Bend

Bend the product in the simulation screen or switch to the next bend step.

### Shift gauge

Shift the gauge manually.

### Manual selection

Manual selection of a bend line. Additional possibility to determine the bend sequence.

### Compute

Compute a valid bend sequence. During the computation the bend sequence computation can be cancelled or stopped;

- Cancel is shown when no valid bend sequence has been computed yet
- Stop is shown when a valid bend sequence has been computed already. This could be the not optimum in production time.

### Assignments

Open a screen with assignments, parameters for the bend sequence computation.

### Bend Sequence

To start a new bendsequence, to reload the original bendsequence or to save a complete bend sequence. These functions can be found under the bend sequence command button.

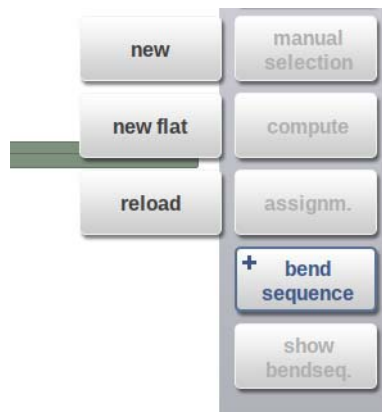

#### +New

Start a new bend sequence, any existing sequence is removed. This is for automatic computed bend sequences.

#### +New Flat

Start a new bend sequence from a flat sheet. This is for manual determined bend sequences.

#### +Reload

Restore an existing bend sequence from disk, but disregard any related CNC program. This is also including corrections.

After a bendsequence has been calculated or determined, the Save and Save as can also be

found in this menu.

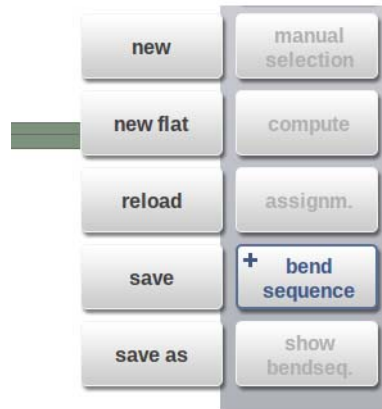

### **+Save**

Save a bendsequence will save the resulting CNC program on disk. The resulting CNC program contains all necessary axis positions and tool numbers. This command can only be executed when a complete bend sequence has been determined.

### **+Save as**

Save as can be used to save the current product and its bendsequence under an alternative name. This enables an easy way to make product differentiations (variants).

When the bendsequence screen is left, the product will automatically be saved. If there are changes made, and save is not used, this will be prompted on the screen.

### **Show Bendsequence**

To show a mosaic screen with a step-by-step graphical overview of the bend sequence.

#### **5.1.1. Bend selector**

Within the bendsequence screen bends can be selected and navigated thru with the bend selector. In the top of the screen the number of bends is indicated with preliminary bend selectors. After completing the bend sequence, these are all colored, active and show a turn indicator.



From then bends can be tapped to easily to select the desired bend data. In the bend selector the turn indicator will be displayed showing green, yellow or red colors to indicate the level of complying the assignments of the bend sequence.



## 5.2. Unbend product

In order to generate a CNC-program the bend sequence must be known. There are two ways to achieve this:

- Press the function key Compute. The control will automatically compute the quickest possible bend sequence for this product.
- Press the function key Unbend repeatedly, until the product is completely unbent.

When the product is completely unbent, press the function Bend sequence and Save to generate and save the CNC-program.

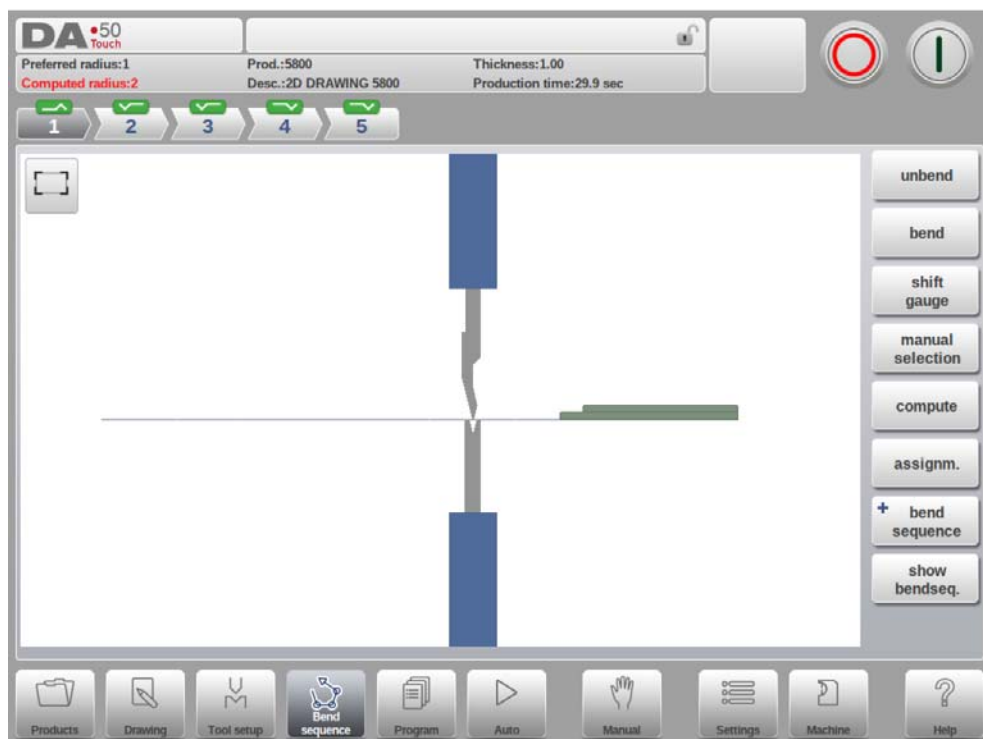

It is possible that no bend sequence has been found for various reasons:

- The installed tools are not correct. Return to the tool configuration menu to change the tool configuration.
- The assignments are incorrect. Return to the assignments menu to modify the assignments.
- A collision has been detected during unbending. It is possible to manually adjust the bend sequence with the available functions. This is explained in the following sections.

---

### 5.3. Manual selection of bends

Normally the control proposes the next (un)bend in a sequence. This is computed by the control depending on the programmed assignments and of course the product shape and applied tools. For various reasons it can be necessary to choose another bend line for the bend sequence. The bend sequence can be changed/determined through the function Manual Selection. When the function Manual Selection has been chosen, a new window is opened.

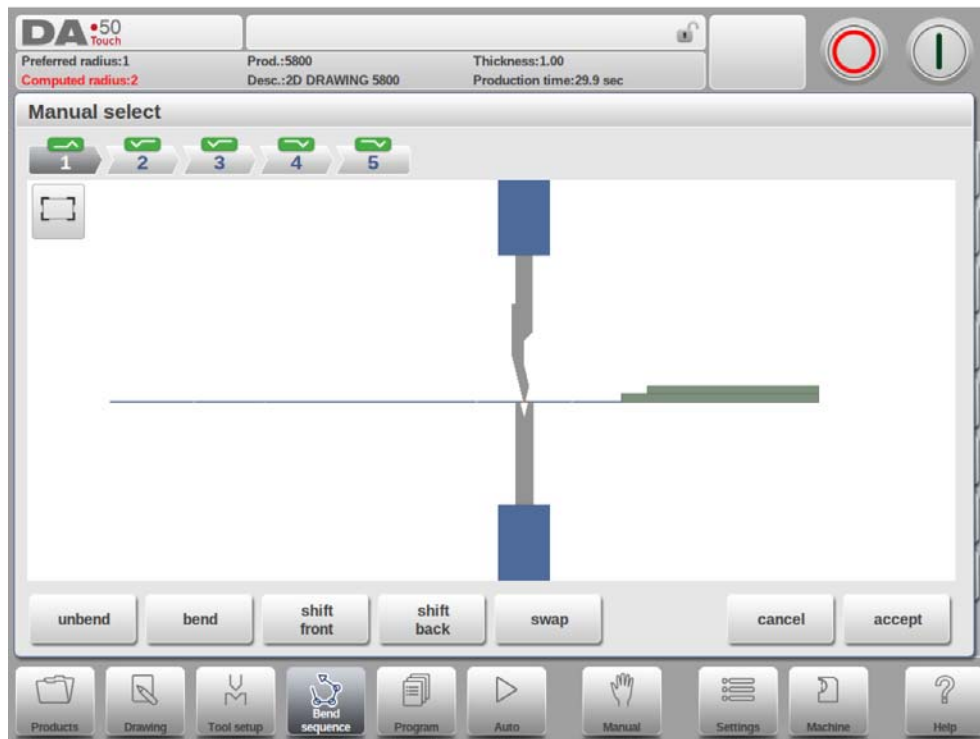

### Functions

#### Unbend

Unbend the currently shown bend or start searching for the next feasible bend to unfold.

#### Bend

Bend the product in the simulation screen or switch to the next bend step

#### Shift Front

Shift the product to the front.

#### Shift Back

Shift the product to the back.

#### Swap

Turn the product between the tools (back to front).

#### Cancel

Leave the current screen without saving changes.

## Accept

Save the changes and leave the current screen.

### 5.3.1. Shift gauge

The control automatically computes at each bend the X axes and R axes positions. It takes into account the values of the option assignments and searches for a solution without collision of the fingers with the product. In order to be able to choose alternative positions, you can move the fingers manually by selecting the function Shift Gauge. A new window appears.

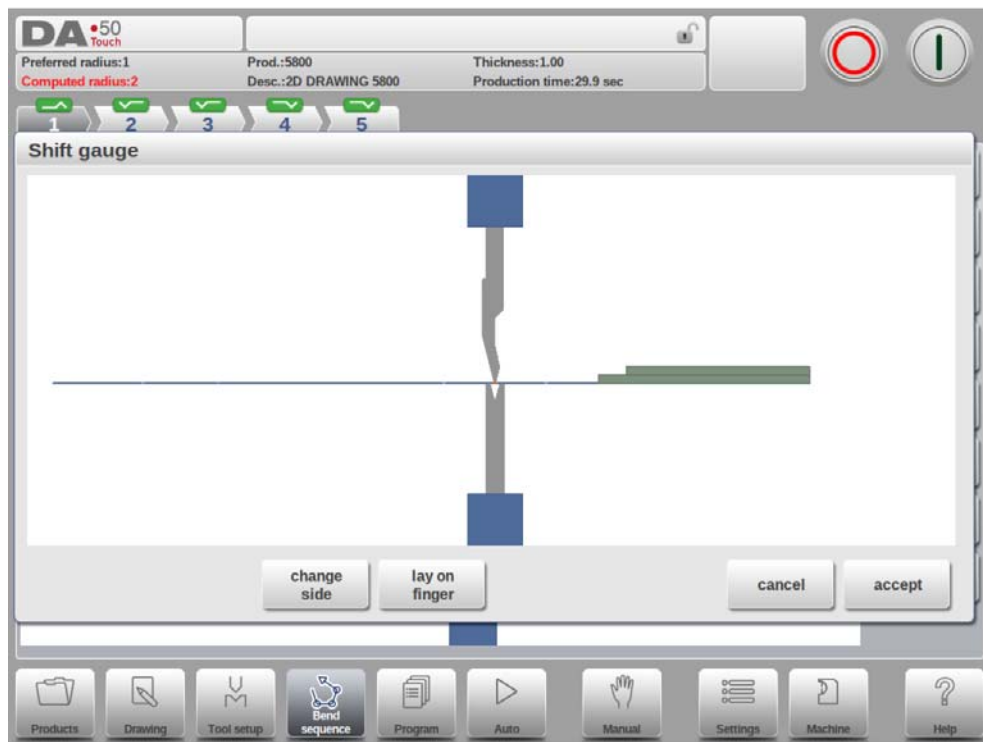

The fingers can be moved by means of the different available functions.

## Functions

### Change Side

Move the finger to another side of the product behind the machine. In the example below there are two possible finger positions to choose; the second position is only possible in case you have an R-axis in your machine.

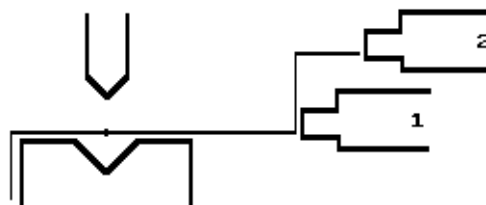

---

**Lay On Finger**

Toggle between lay product on selected finger or not. This option is only selectable in case you have an R-axis in your machine.

**Cancel**

Leave the current screen without saving changes.

**Accept**

Save the changes and leave the current screen.

## 5.4. Assignments

### 5.4.1. Introduction

The Assignments are parameters with which the bend sequence computation is controlled. The assignments screen is opened from the tool configuration screen with the function key Assignm.

Automatic bend sequence computation works with several conditions in order to find an optimum between a minimum production time, handling possibilities without product/machine and product/tool collision.

In order to find one of the optimums you must program several computation parameters with which the bend sequence can be computed. Some of these parameters are machine-related and some are related to product accuracy, handling possibilities and turn times.

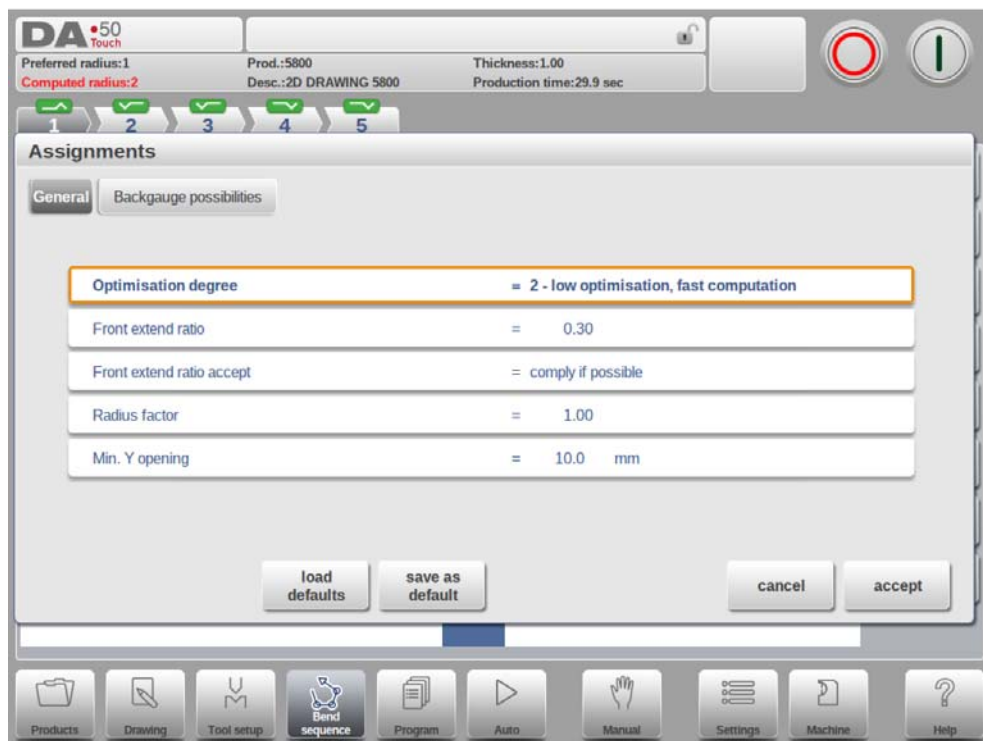

## Functions

### Load defaults

Load default assignment settings. It is possible to determine a set of assignments which have the most optimal values for your situation. This set can be stored by tapping Save As Default. While programming another product you can recall this previous fixed set by loading the values via Load Defaults.

### Save As Default

Save the current settings as default assignments settings.

### Cancel

---

Leave the current screen without saving changes.

**Accept**

Save the changes and leave the current screen.

**5.4.2. Assignments - general**

**Optimisation degree**

Range 1-5.

The number of alternatives to be computed for each bend must be entered here.

The higher this number the more alternatives are to be examined by the control, so the longer the computing time will be:

- 1 - lowest optimisation, fastest computation
- 2 - low optimisation, fast computation
- 3 - medium optimisation, medium computation
- 4 - high optimisation, slow computation
- 5 - highest optimisation, slowest computation

**Front extend ratio**

Range 0.01 - 1.0.

This is the ratio of the minimum allowable length of your product which extends in front of the press to the total blank length of the product. You must have a minimum length of your product in front of the press to be able to handle the product.

**Front extend ratio accept**

Comply If Possible:

This means that when possible the computer tries to comply to the front extend ratio and only when this will result in no solutions to be found it will accept that the length in front is smaller than the specified ratio.

Comply Always:

The computer will always comply to the front extend ratio. This may result in no solutions to be found.

**Radius factor**

Range 0.1 - 2.0.

The computed radius of a bend is multiplied by this factor for correction purposes. This correction affects the X-axis position and the computed blank length. The initial value of RF is 1.

The control computes the X-axis position necessary to obtain  $L=100$  as shown in the figure below. The accuracy of the length  $L$  is dependent on the material parameters like thickness, strength and kind of material. In order to have a correction possibility with the radius factor RF you can optimise this computation.

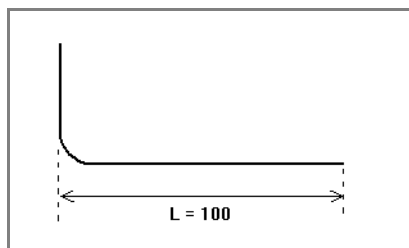

## Minimum Y opening

During postprocessing of the programmed product, the control always computes an optimal opening of the pressbeam to handle your product. Here you can program a minimum required opening. The programmed value is the distance above the speed change point (Mute).

### 5.4.3. Assignments - Backgauge possibilities

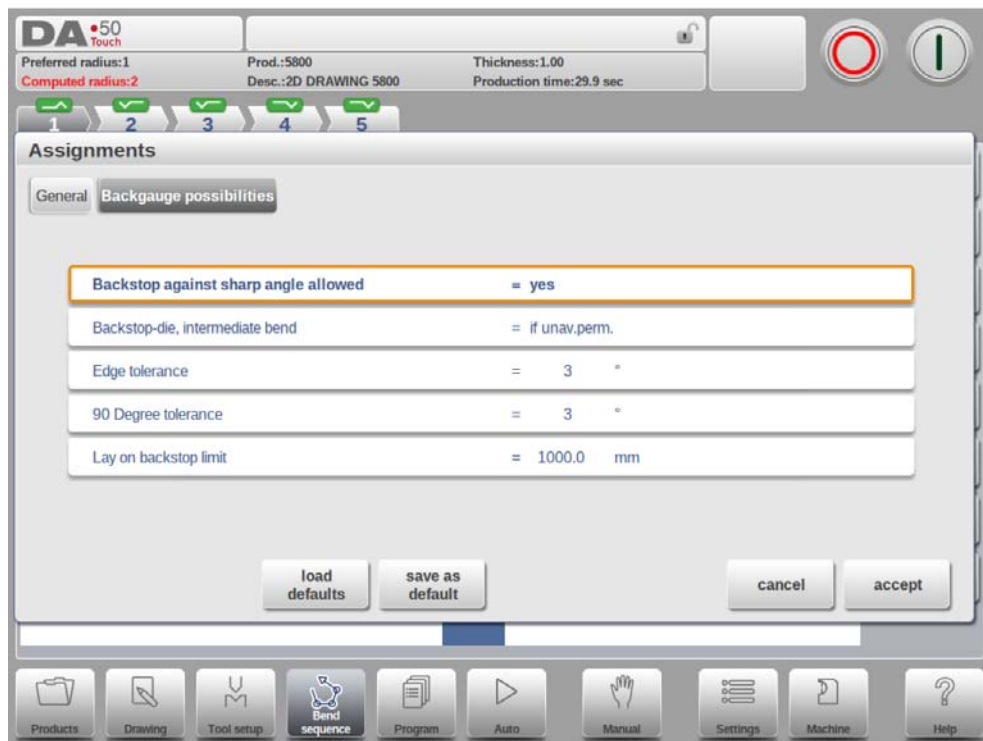

#### Backstop against sharp angle allowed

Specify if backstop may be placed against an angle smaller than 90°.

- No = not allowed
- Yes = allowed

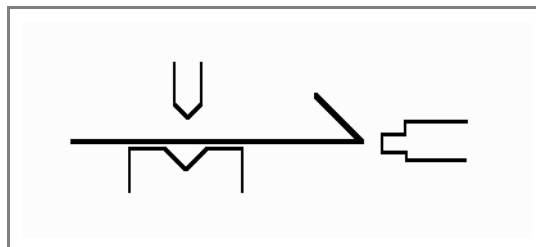

#### Backstop-die, intermediate bend

Set to allow if there may be a bend between the die and backstop.

Selection possibilities:

- Permitted
- If unavoidable permitted: if it results that no solutions are to be found, than it is permitted

- 
- Prohibited: never allowed.

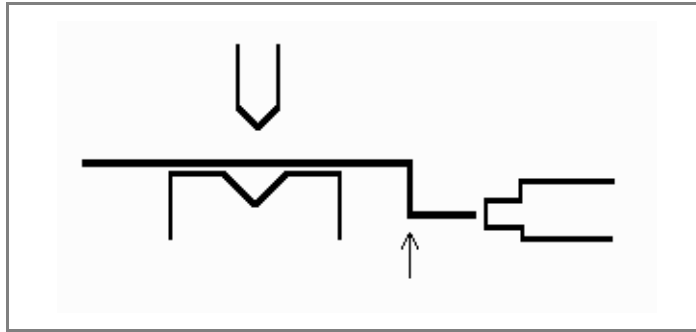

### Edge tolerance

In case backstop is against flat sheet an angle tolerance is allowed (deviation from horizontal). To be programmed in degrees of tolerance (0 - 90° input).

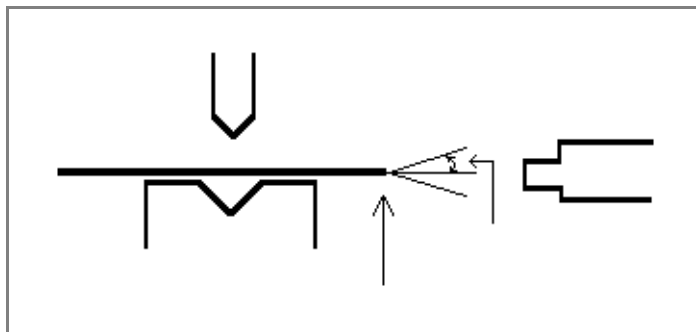

### 90 Degree tolerance

The maximum allowed deviation from vertical (90°), when the backgauge is against a bent angle which is not 90°.

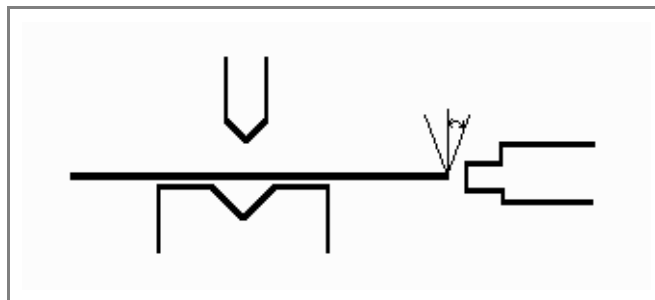

### Lay-on backstop limit

This parameter is useful in case the press brake has been equipped with backgauge fingers on a moving R-axis, having a so-called "lay-on" construction.

When the length of the sheet at the backside of the machine is greater than this limit, the X-axis and R-axis positions will be corrected automatically so the sheet will rest on the backgauge finger. This is only possible if an automatic R-axis is enabled.

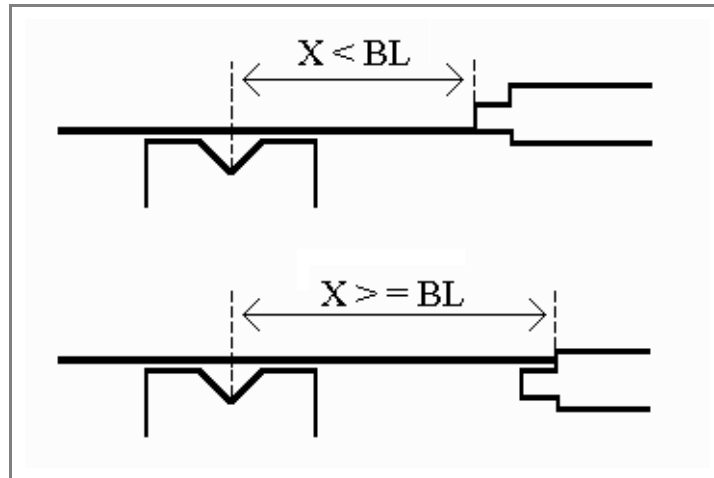

---

## 5.5. Show bend sequence

When the function Show Bend Sequence has been pressed, a graphical overview of the bend sequence is shown.

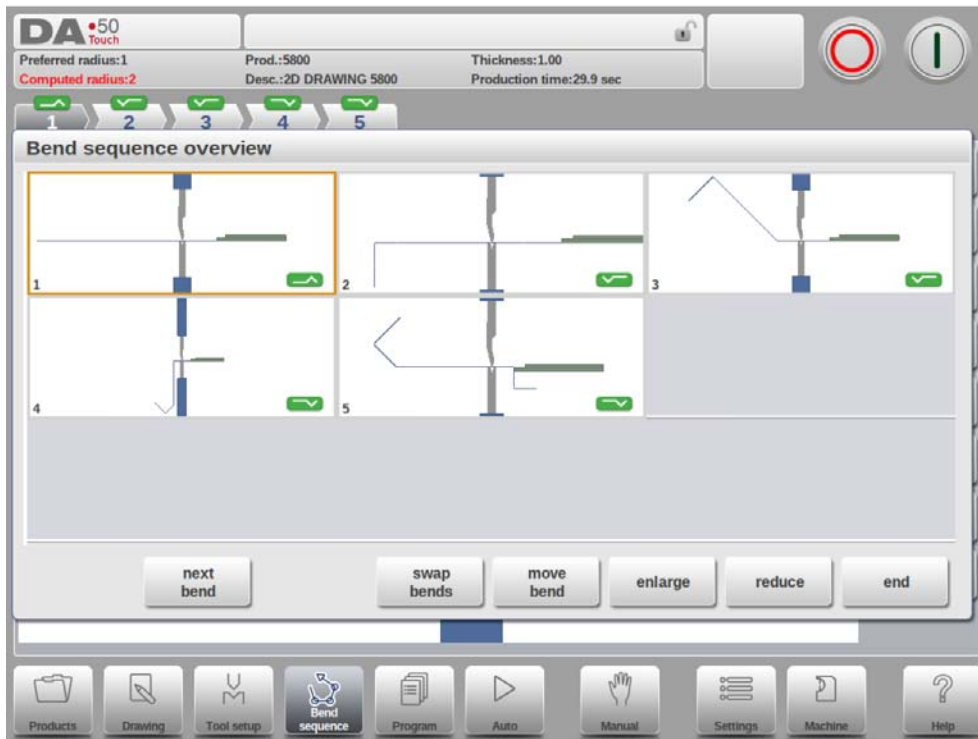

This option can be called at any time after the first unbend has been made. The graphical overview displays the determined bends as well as the not yet determined bends (question mark sign).

Each image in the overview can separately be enlarged or reduced with the available functions. The images can also be rotated by finger movement.

## 6. Product programming

### 6.1. Introduction



To generate or modify a numerical program, start a new program from the Products mode or use Program to enter directly

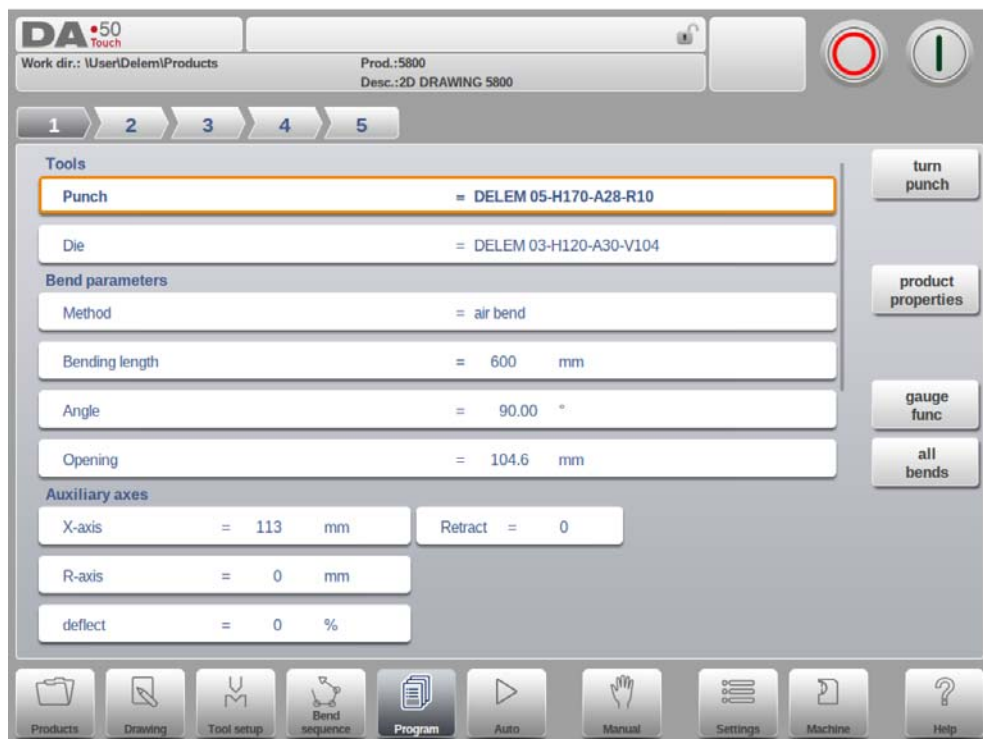

To edit an existing CNC program, select a product in the Products overview and select the navigation button Program. When starting a new program, select New Program and after giving in the main product properties, the system will automatically switch to Program.

In both cases, a screen as shown above should appear. Programming and changing data is done in the same way for both modes.

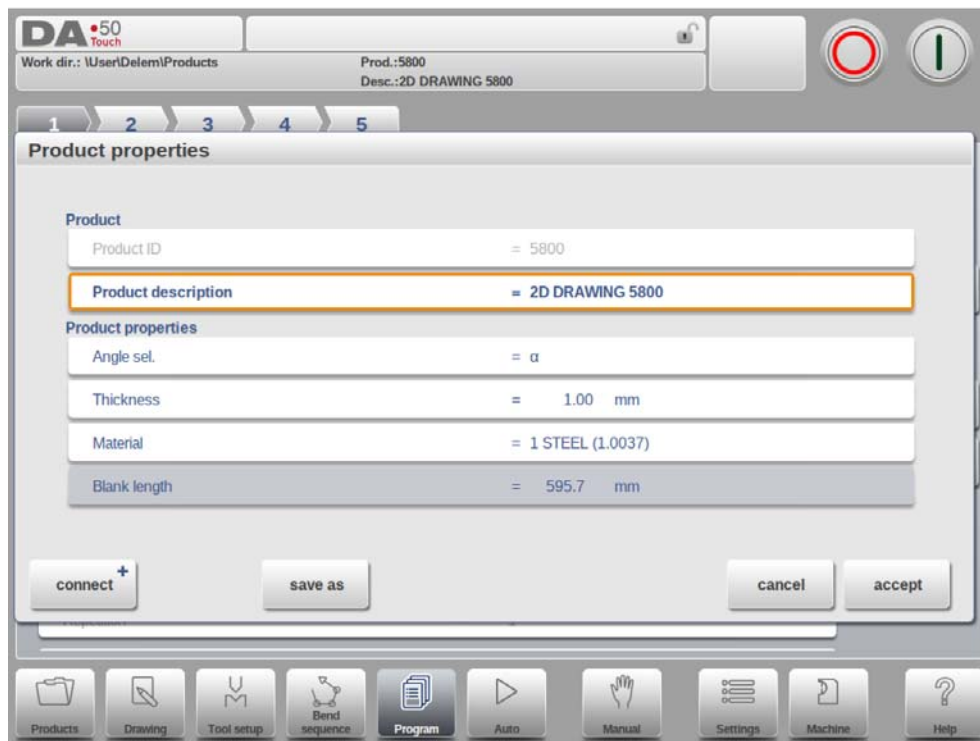

The main screen shows the existing numerical program or, when starting a new program, the first to be programmed bend.

To change the main product properties tap Product Properties. These parameters of the program are the same for every bending of the program (main data of program).

## Functions

### Connect

The function Connect is to have a possibility to connect certain programs to one another. This option can be used to produce 3-dimensional products out of two programs.

### +Connect program

With the function Connect it is possible to create a 3-dimensional product. The control automatically executes the bend sequences in the different directions in succession. You program the control as follows:

- 1 Create the product in one direction.
- 2 Create the product in the other direction.

There are now two bend programs of one product in two directions. You connect these programs as follows:

- 1 Select the program with the bend sequence in the direction which you want to execute in the first place. You select the program of the product via the 'product library'.
- 2 Go to the Program mode and select Product properties.
- 3 In the Product properties window you select the function Connect and Connect program.

- 4 Select the product ID of the product in the other direction.
- 5 Select the second program as in step 1. Repeat steps 2 to 4. If you want to connect two programs, as in this example, you enter the product ID of the first program. The cycle is closed.

When you want to execute more than two programs in succession (not necessarily to create a 3-dimensional product) the second program must refer to the third. The third program to the fourth and so on. The final program of the cycle must always refer to the first program.

To produce products with connected programs the next four actions are necessary.

- 1 Select the first program
- 2 Select the Automatic mode
- 3 Program the amount of products you want to produce with the 'stock count' parameter.
- 4 Push the Start key.

When the first program has been finished the second program starts automatically. The program counter indicates the remaining amount of repeats.

#### **+Disconnect program**

To stop the sequence of connected programs.

#### **Save as**

Copy the current product. When pressed, you must enter a new product ID for the copy program.

#### **Change directory**

Choose another location (directory) on the local disk to store the current product. The product is automatically copied to the new location.

---

## Parameter explanation

### Product ID

A unique name to identify a product program. The maximum length is 25 characters. The product ID may contain letters and numbers.

### Product description

A number or description of this program. The maximum length is 25 characters. The product description may contain letters and numbers.

### Angle selection

Selection of the programming mode for the Y-axis.

0 = absolute: program the absolute Y-axis position for a bend.

1 =  $\alpha$ : program the angle to bend. The required Y-axis position is computed.

Depending on this parameter, either the parameter Angle or the parameter Bend Position will appear in a bend step.

### Thickness

Thickness of the sheet.

### Material

Selection of one of the programmed materials, which are used to calculate the bending depths. The control contains 6 pre-programmed materials. In total, 99 materials can be programmed on the control. The materials can be programmed on the Materials page in the Settings mode.

	E-MODULE (N/mm <sup>2</sup> )	TENSILE STRENGTH (N/mm <sup>2</sup> )
1 = Steel	210.000	400
2 = Aluminium	70.000	200
3 = Zinc	94.000	200
4 = Stainless steel	210.000	700
5 = Material 5	210.000	400
6 = Material 6	210.000	400

### Blank length

The required length of the original sheet from which the product is bent. If the program has been processed from a 2D drawing, this value has been calculated.

The main screen shows the available bends and from this main screen, from every available bend, specific parameters can be viewed and edited.

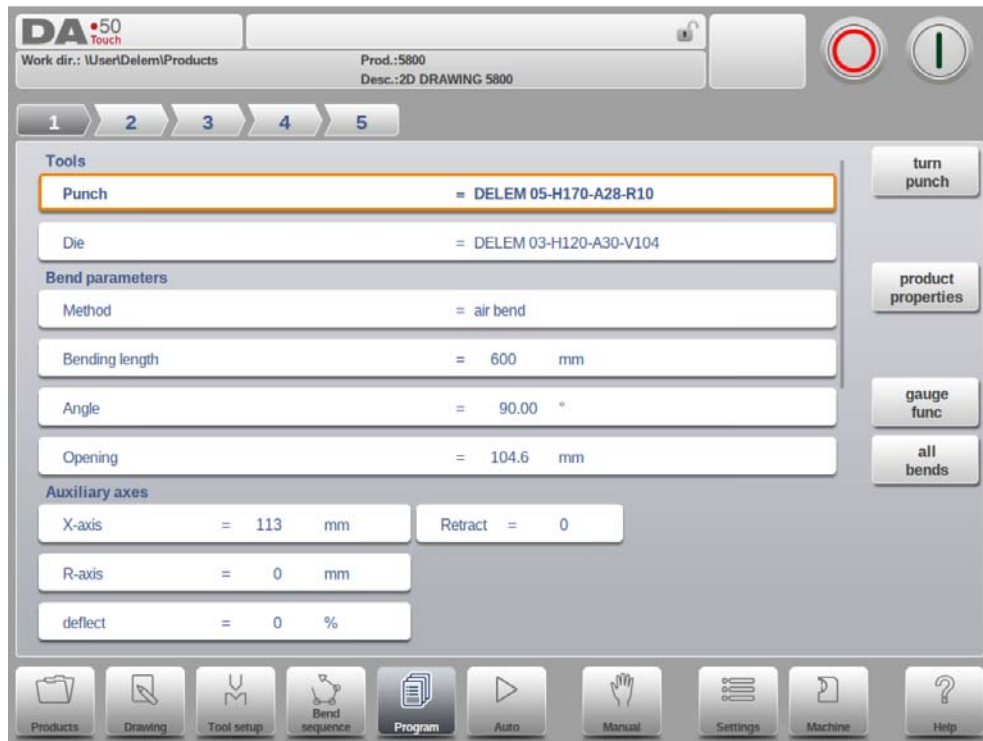

The bend selector in the top of the screen can be used to navigate thru the bends. The indicated bends can be tapped to easily select the desired bend data.

### **Product Properties**

Opens a new window, in which product properties, effective for all bends, are shown and can be edited.

### **Gauge Functions**

Opens a window in which axes positions in relation to finger positions can be programmed.

### **All Bends**

Opens a new window, in which all bends are shown in a table.

See more on these functions further in this paragraph.

---

## 6.2. Bend parameters

The parameters of every bend are listed on one page and can be scrolled thru. Below the specific bend parameters are explained.

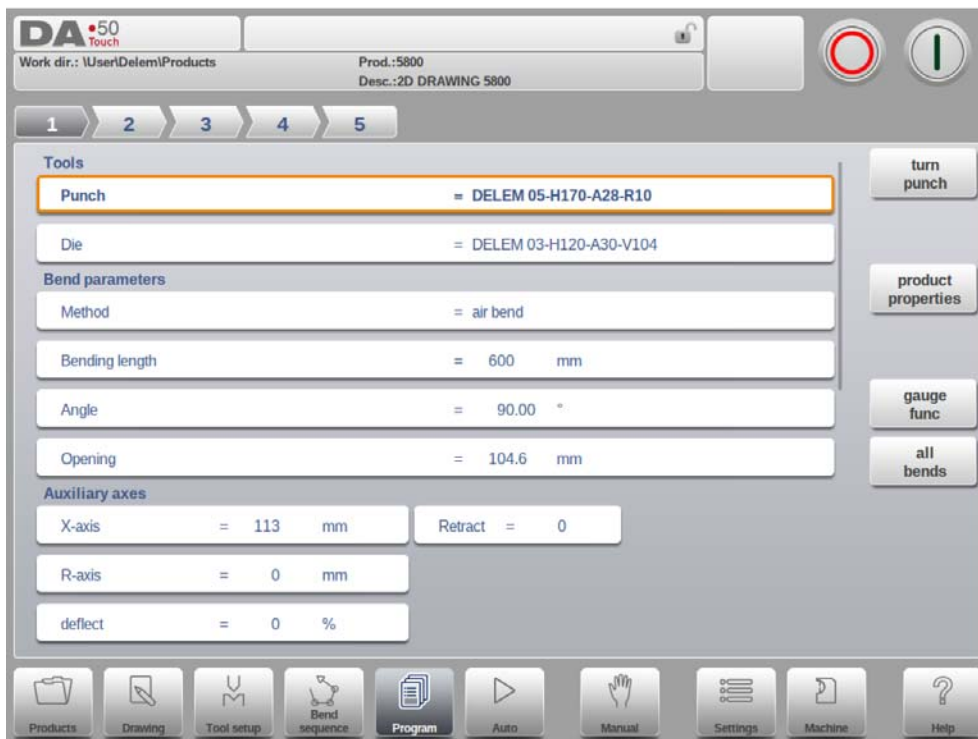

The product ID and product description are displayed in the top row on the screen.

### Tools

#### Punch

The name (ID) of the selected punch. Tap to modify or select from the punch library.

#### Die

The name (ID) of the selected die. Tap to modify or select from the die library.

Program the desired tool ID or press the tool to get an overview of the available tools in the library. Press the function Turn Punch or Turn Die to change the orientation of the tool (i.e. to turn the tool around).

#### Turn Punch / Turn Die

Turn around the applied tool (back to front). Only available if the cursor is placed on a tool parameter.

## Bend parameters

### Method

Select the required bending method. The control supports 4 methods:

- air bend
- bottoming
- hemming
- hemming & bottoming
- handling

### Bend methods

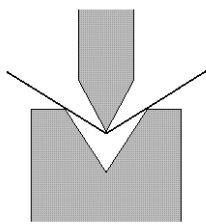

air bend

The sheet is bent to the programmed angle by bringing the punch to the required depth. The control calculates the required Y-axis position to obtain the programmed angle.

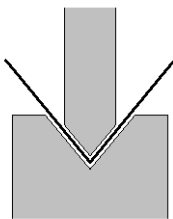

bottoming

The sheet is bent by pressing the sheet between the punch and the die. The control assumes the bottom of the die as required Y-axis position.

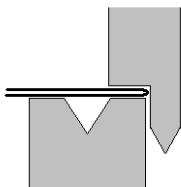

hemming

The sheet is folded in two. This is possible after the sheet has been bent into a sharp angle in a previous bend. The control calculates the precise Y-axis position for this action: the surface of the die plus twice the sheet thickness.

Y-axis positioning can be adjusted by programming a 'hem opening'.

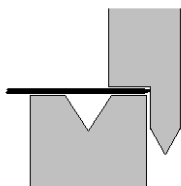

hemming & bottoming

The same as hemming, but now the control assumes the top of the die as required Y-axis position. The folded sheet is pressing between punch and die.

handling

No movement of the Y-axis, so the current program step becomes a non-bending step. Only the backgauge axes will position according to the programmed values, e.g. in order to enable handling of the product. An external step change (C-input) is required.

---

**Note 1**

The hemming bends are shown here with a special hemming punch, but this is not required.

**Note 2**

When bottoming operation is selected, the end of bend position of the Y-axis beam depends on the working force. If however the force is sufficient for the beam to go to the calculated Y-axis end of bend position, the beam stroke will be limited by the position value.

**Bending length**

Length of the sheet between tools.

**Angle**

The required angle of this bend. This parameter only appears if angle programming is selected with the parameter 'Angle sel.' and the bend method is an air bend.

**Hem opening**

The hem bend can be made with a certain opening distance between the 2 flanges. The hem opening value will be used calculating the beam position in the hemming process. By default this parameter has the value of the Settings mode parameter Default Hem Opening.

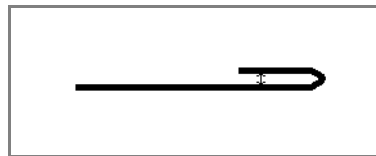
**Bend position**

The required Y-axis position for this bend. This parameter only appears if absolute programming is selected with the parameter 'Angle sel.' This parameter also appears if the bend method is bottoming and/or hemming.

**Opening**

This parameter results in a certain gap opening between the punch and the die after the bend. A positive value is the gap opening above Mute, a negative value below Mute. When you want to limit the handling time of the product you can program a small positive or a negative value.

**Auxiliary axis**

The position of the selected axis.

When a negative value is programmed for an X-axis this value is interpreted as a relative value. This value is subtracted from the actual X-axis position. Therefore this parameter can also be used as a chaining measure.

**Retract**

Retract distance of the selected axis in the current bend. The "backgauge retract" is started when the beam is pinching the sheet.

**Axis speeds**

Speed of the selected axis in the current bend. Speed can be programmed in a percentage of the maximum possible speed.

## Gauge function

The function key Gauge Func opens the gauge functions window. In this window several backgauge related parameters can be programmed. These parameters serve to program the desired finger positions for a certain bend. The necessary axis positions that are necessary for this bend are calculated from the programmed finger positions.

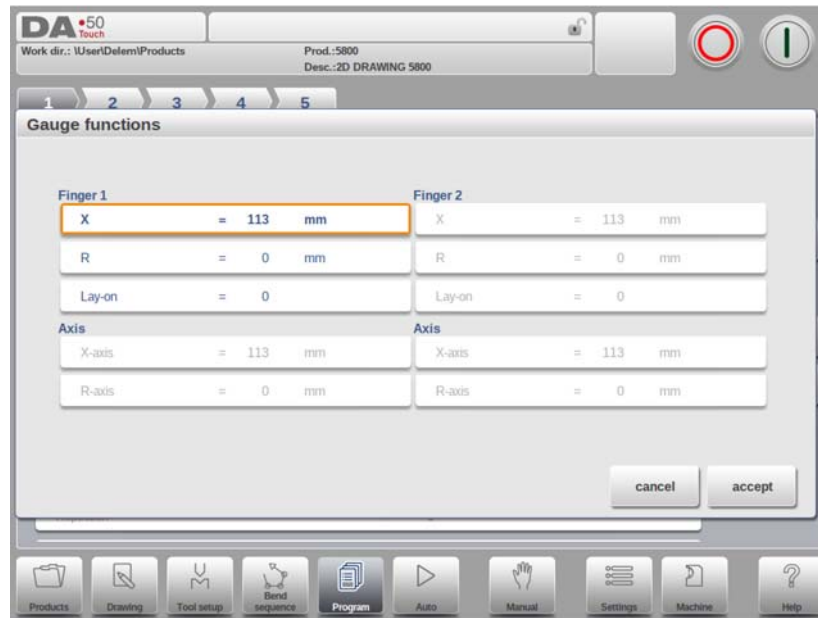

### X

The value in X-direction of the finger position for the sheet. This value can manually be adjusted in this window, if required.

### R

The value in R-direction of the finger position of the sheet. This value can manually be adjusted in this window, if required.

### Lay-on

With this parameter you can program another finger position for this specific bend. The finger position you can program depends on the back gauge possibilities. Back gauge dimensions are programmed in the Machine mode.

- Lay-on = 0: no lay on (default)

Other possibilities are:

- Lay-on = 1: lay on first level
- Lay-on = 2: lay on second level
- Lay-on = 3: lay on third level

When you program another Lay-on the axis positions change, but the gauge position for the sheet does not change. This means that the previous two parameters R and X remain the same. See also example below.

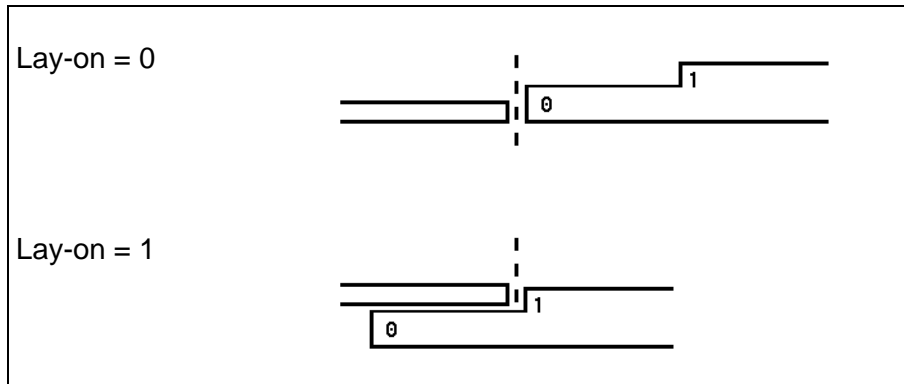

With Accept you leave the window and the new values have been saved. If you press Cancel you leave the window without changes.

When you have changed Lay-on then the axes positions in X- and R-direction have been changed. The new values depend on the dimensions of the back gauge finger which you have programmed in the Machine mode. When you have changed the values of R and X, then these changes are also included.

## 6.3. Bend functions

Auxiliary functions of the bending can be programmed scrolling down the bend parameters page.

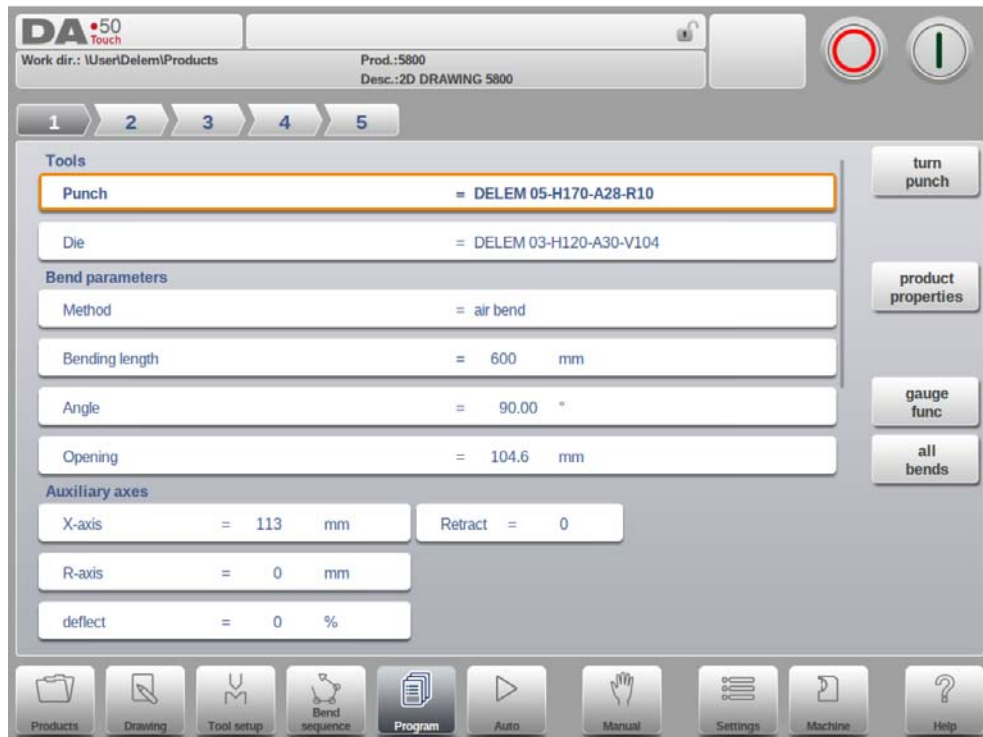

### Mute

Sequence point at which the Y-axis is switched from fast closing speed to pressing speed. The value programmed here is the distance of the mute point above the sheet. By default, the mute value from the programmed die is used. Whether or not this parameter is present depends on machine settings.

### Parallelism

Difference of left- and right hand side cylinder (Y1 and Y2). When positive, right hand side lower. When negative, right hand side higher. The programmed value is active below the clamping point.

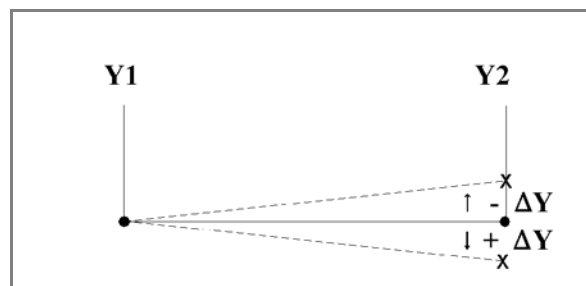

---

**Repetition**

0 = bending is skipped

1 through 99 = the number of times this bending will be repeated.

**Wait for retract**

In case of a retract, let the Y-axis wait until the retract is finished, yes or no.

No: the retract is started when the Y-axis passes the clamping point, the Y-axis does not stop.

Yes: when the Y-axis reaches the clamping point, the Y-axis is stopped and the retract is started. When the retract is completed, the Y-axis moves on.

**Step change code**

Programmable parameter which determines when the parameter values for the next bending will be active. The following settings are possible:

0 = ER: Bending number change (step change) at end of decompression (next bend parameters active).

1 = MUTE: Step change at muting position when the beam moves in opening direction.

2 = UDP: Step change at upper dead point.

3 = UDP STOP: Step change at upper dead point without movement of any axis and the control goes to "stop".

4 = EXTERNAL: Step change if C-input signal becomes active, without movement of the beam. When you still have a beam movement there will be no retract function of the back gauge performed. See also code 5.

5 = UDP EXTERNAL: Step change if C-input signal becomes active and the beam is in the upper dead point. Now you may move the beam and the retract function of the back gauge will be performed.

**Delay time**

Programmable delay time before step change (0-30sec)

**Force**

Maximum adjusted force during pressing (automatically computed).

**Dwell time**

Holding time of punch at bending point.

**Decompression**

Decompression stroke after bending to release the working pressure

**Pressing speed**

Working speed (pressing speed). Initially, the value for this parameter is copied from the parameter Default Pressing Speed in the Settings mode.

**Decompression speed**

The decompression speed is the programmable speed which is active during the programmed decompression stroke.

**Note**

After selecting a new bend this will be a copy of the preceding one; you only have to alter those parameters which are different from the preceding bend.

## Bend parameters - All Bends

When the function All Bends has been pressed, a complete overview of the bends appears. After pushing End the page from which this page was selected will be restored, with the cursor on the parameter selected before.

Bend ▲	Angle	Opening	Force	Method	Code	Wait for retract	X-axis
1	90.00	104.6	33	air bend	UDP	no	113
2	135.00	92.0	33	air bend	UDP	no	180
3	90.00	92.7	33	air bend	UDP	no	98
4	90.00	58.0	33	air bend	UDP	no	58
5	90.00	54.8	33	air bend	UDP	no	57

Specific bend can be selected on the screen by putting the highlighted bar on that bend, then selecting END.

From within this screen, the complete CNC program can be edited. All bend parameters can be edited within the table and bends can be swapped, moved, added and deleted.

The available columns can be scrolled by finger movement / swipe.

## Functions

### Edit

Edit the program with one of the following commands:

- insert bend
- mark bend
- delete bend

When the function Edit has been pressed a new, temporary button bar appears with additional functions:

### +Insert Bend

To insert a new bend between one of the bends. When pressed, the current bend is copied and added after the current bend.

### +Mark Bend

---

Mark the current bend, in order to prepare it for another action, like move or swap. See description below.

**+Delete Bend**

To delete the bend that is currently selected.

When a bend has been marked with the function key Mark Bend several other functions become available:

**+Move Bend**

In the table overview of the bend sequence, it is possible to change the order of bends simply by moving a bend to another place. Select the bend that must be moved. Then press the button Mark Bend and the bend is highlighted. Now select the right place in the sequence. When the correct bend is highlighted, press Move Bend. The bend will be inserted on the current place.

**+Swap Bends**

With this command, two bends can change place in the bend sequence. Move the cursor to one of the required bends and press the Mark Bend button. Then move the cursor to the bend with which it must be swapped and press Swap Bends. If for any reason the action must be cancelled, press the function Abort Mark during the procedure.

**+Abort Mark**

Remove the mark from the currently marked bend.

A bend is no longer marked when the mark is aborted, when an action is finished or when this menu is left.

**Copy Column**

Copy the value of the currently selected parameter in the current bend to all other bends.

**Turn Punch / Turn Die**

Turn around the applied tool (back to front), as already explained earlier in this chapter. Only available if the cursor is placed on a tool parameter or tool orientation parameter.

**Gauge Func**

Program the gauge positions, as already explained earlier in this chapter.

## 6.4. Special edit remarks

After changing program data the control will not automatically calculate:

- 1 Force
- 2 Decompression
- 3 Crowning device setting
- 4 X-axis position correction

Parameters 1 through 3 are only automatically recalculated if the parameter Auto Computations Edit (see the Settings mode) has been enabled.

Parameter 4 is only automatically recalculated if the parameter Active Bend Allowance Table (see the Settings mode) has been activated. Corrections on the X-axis position can be edited with the parameter Corr.X (per bend) and G-corr.X (for all the bends of the active program) in the Automatic mode.

There is one exception:

When the parameter Bend Method is changed the Force and Decompression will be adjusted automatically.

---

## 7. Automatic mode

### 7.1. Introduction



By tapping the navigation button Auto the control is switched to the automatic production mode.

In auto mode with the active program, production can be started. After entering Auto, the Start button can be pressed and production can begin.

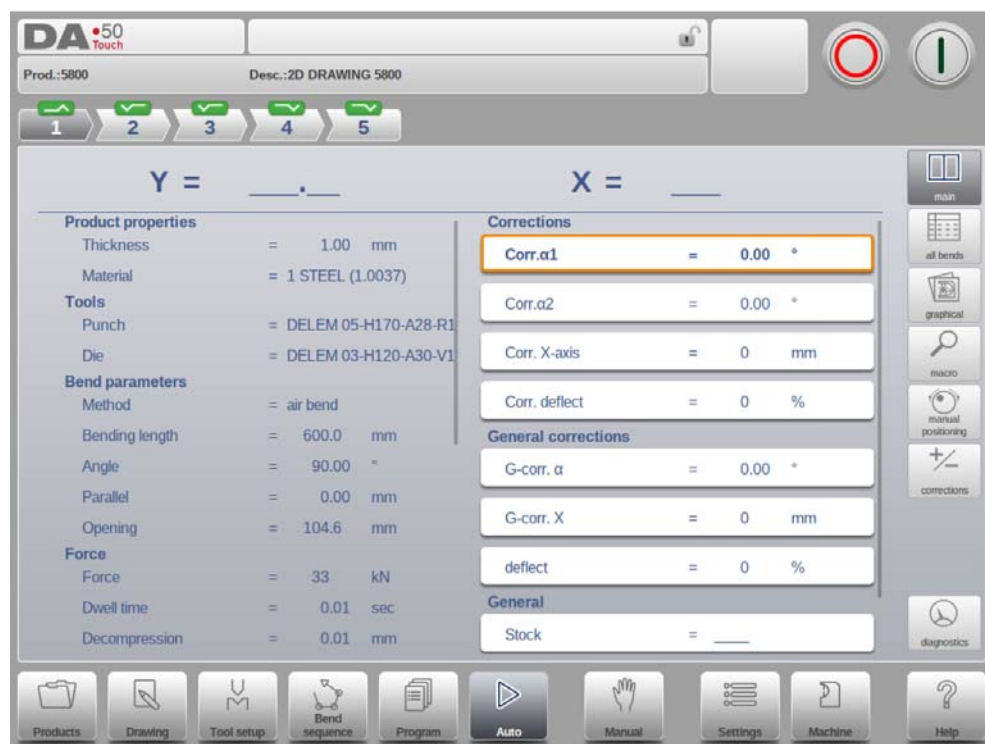

The automatic mode executes the program automatically bend by bend after pushing the Start button. When selecting a different product in Products mode, which is in the library and has already been used for production, one can immediately switch to Auto and start production. Every time after a different bending program is selected you must check your tools and tool positions in your machine. This is also indicated with a 'check tools' warning message when you enter the automatic mode.

In the header of the Auto mode screen the selected product is displayed along with the product description. At the top of the screen the bend selector shows the available bends in the program. By tapping the preferred bend the bend can be selected. The start button can be pressed to start from this bend. The details of the selected bend are shown in the available views.

---

The repetition of a bend and the connected programs, when applicable, are shown in the header of the screen. A connected program is also indicated in the bend selectors last position.

### 7.1.1. Auto mode, parameter explanation

Following is a list of the available parameters in Auto mode.

#### Corrections

##### Angle 1 / Angle 2

Corrections on angle values in this bending.

Angle corrections can be programmed for both sides of the machine, Y1 and Y2. When correction Angle 1 is entered for one side, this value is automatically copied to the correction Angle 2 for the other side. The correction for the other side can then be changed. When both angle corrections have been entered, the resulting corrections for Y-axis and parallelism are calculated. The corrections will be saved in the active bending program.

The angle correction should be entered as following examples indicate:

Programmed value of 90 degrees.

Measured value of 92 degrees.

-> Then it is required to program of correction of -2.

Programmed value of 90 degrees.

Measured value of 88 degrees.

-> Then it is required to program a correction of +2.

In case the angle correction database has been switched on, the control checks whether a correction exists for this type of bend in the database. The result of this check is prompted in the entry field:

- No stored correction.  
No correction has been found for this bend
- Stored correction.  
A correction that matches the current bend has been found
- Interpolated correction.  
A correction has been calculated (interpolated) based on other existing corrections

If a correction is entered, it will be stored in the database. At each next bend with the same properties, this same correction will be offered.

The angle correction database can be found on the Program Settings page in the Settings mode.

##### Y1 / Y2

Corrections on the Y-axis positions, in case absolute programming is used or bottoming is selected for a bend.

##### Auxiliary axis

Corrections on auxiliary axis positions in this bending. In case bend allowance is activated (see the Settings mode) and a program has been entered in data preparation, the X-axes correction values are the result of bend allowance calculation. The

corrections will be saved in the active bending program.

The auxiliary axis correction should be entered as following examples indicate:

Programmed value of 200 millimetres.

Measured value of 202 millimetres.

-> Then it is required to program a correction of -2.

Programmed value of 200 millimetres.

Measured value of 198 millimetres.

-> Then it is required to program a correction of +2.

## **deflect**

Correction on the crowning device.

Only available if a crowning device is present

## **General corrections**

### **Angle**

General correction of the angle, valid for each bend of the program. The value should be programmed in the same manner as for the correction per bend.

### **Depth**

General correction on the Y-axis position, in case 'absolute programming' is used and 'air bend' is selected for a bend. This correction is valid for each bend of the program.

### **X-axes**

General correction of the X-axis position, valid for each bend of the program. The value should be programmed in the same manner as for the correction per bend.

## **deflect**

General correction on the crowning device.

Only available if a crowning device is present.

## **General**

### **Step mode**

Select to use either Auto mode (disabled) or Step mode (enabled). In Step mode you have the same possibilities as in Auto mode. There is only one difference. After each bend cycle, the control will stop. To continue working, you must start the control again by pressing the Start button on the front panel of the control.

### **Stock**

The stock counter is incremented or decremented after each end of a program cycle.

### **Repetition**

Selection of one of the repeated steps of one bend. Useful if a bend has a repetition value larger than 1. This parameter is visible when the function Select Rept. No. is pressed.

---

## 7.2. View modes

The auto mode screen is offering a diversity of views which, depending on ones production methode, can be chosen. When selecting auto mode for the first time, the main screen will appear. On the right side of the screen the available view modes can be selected.

Following view modes are available:



Main, numerical bend data. See for details paragraph 7.2.1

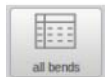

All bends, shows all bend data in a table. See for details paragraph 7.2.2



Graphical, full screen graphical visualisation of the selected bend. See for details paragraph 7.2.3



Macro, large visualisation of axes values shown in a list. See for details paragraph 7.2.4



Manual positioning, large visualisation of axes values with the posibility to move axes from their position and teach the axis value in the selected bend. See for details paragraph 7.2.5



Corrections, all correction values for angle as well as axes positions. See for details paragraph 7.2.6



Diagnostics, special information on the axes positioning and I/O status of the control system. This view mode is meant for service purposes. See for details paragraph 7.2.7

The appropriate view can be switched from and to, not changing the bend data. The Start will not jump to Stop while switching view modes.

## 7.2.1. Main

Main view shows the numerical data of the bend along with the corrections. The corrections can be programmed here.

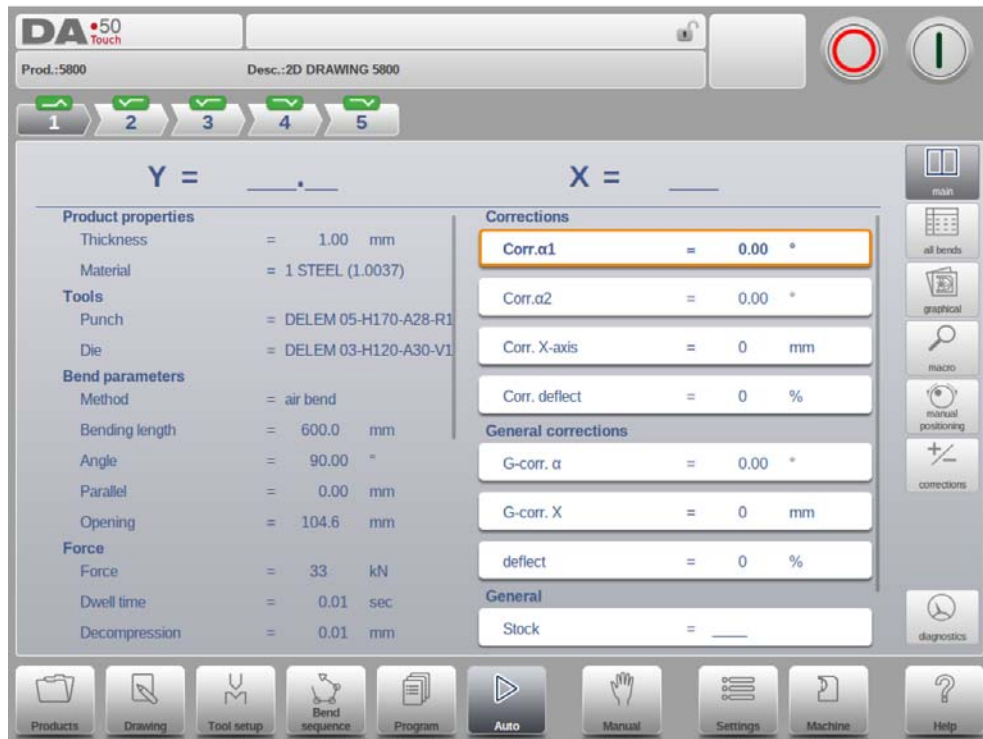

Both columns can be scrolled to see all data.

### Bend selector

The bend selector in the top of the screen can be used to navigate thru the bends. The indicated bends can be tapped to easily select the desired bend data. In the bend selector the turn indicator will be displayed showing green, yellow or red colors to indicate the level of complying the assignments of the bend sequence.



---

## 7.2.2. All bends

The all bends view mode shows a table including all bend data. The bends are shown row wise and the columns display all bend parameters.

During bending the control will step through the list and corrections belonging to the selected bend are shown in the lower part of the screen.

The screenshot displays the 'All bends' view in the DA 50 Touch control interface. The interface features a top status bar with 'Prod.:5800' and 'Desc.:2D DRAWING 5800'. Below this is a navigation bar with five steps, where step 1 is selected. The main area shows a table of bend parameters with columns: Bend Angle, Opening, Force, Method, Code, Wait, Lay-on X-axis, X-axis Retract, and R-axis deflect. The table contains five rows of data. A bottom toolbar contains icons for Products, Drawing, Tool setup, Bend sequence, Program, Auto, Manual, Settings, Machine, and Help. A right sidebar contains icons for main, all bends, graphical, macro, manual positioning, corrections, and diagnostics.

Bend	Angle	Opening	Force	Method	Code	Wait	Lay-on X-axis	X-axis Retract	R-axis deflect
1	90.00	104.6	33	air bend	UDP	no	0/0 113	0 0	
2	135.00	92.0	33	air bend	UDP	no	0/0 180	0 0	
3	90.00	92.7	33	air bend	UDP	no	0/0 98	0 0	
4	90.00	58.0	33	air bend	UDP	no	0/0 58	0 0	
5	90.00	54.8	33	air bend	UDP	no	0/0 57	77 -12	

## 7.2.3. Graphical

In graphical view mode a full screen graphical view of the bend process is given.

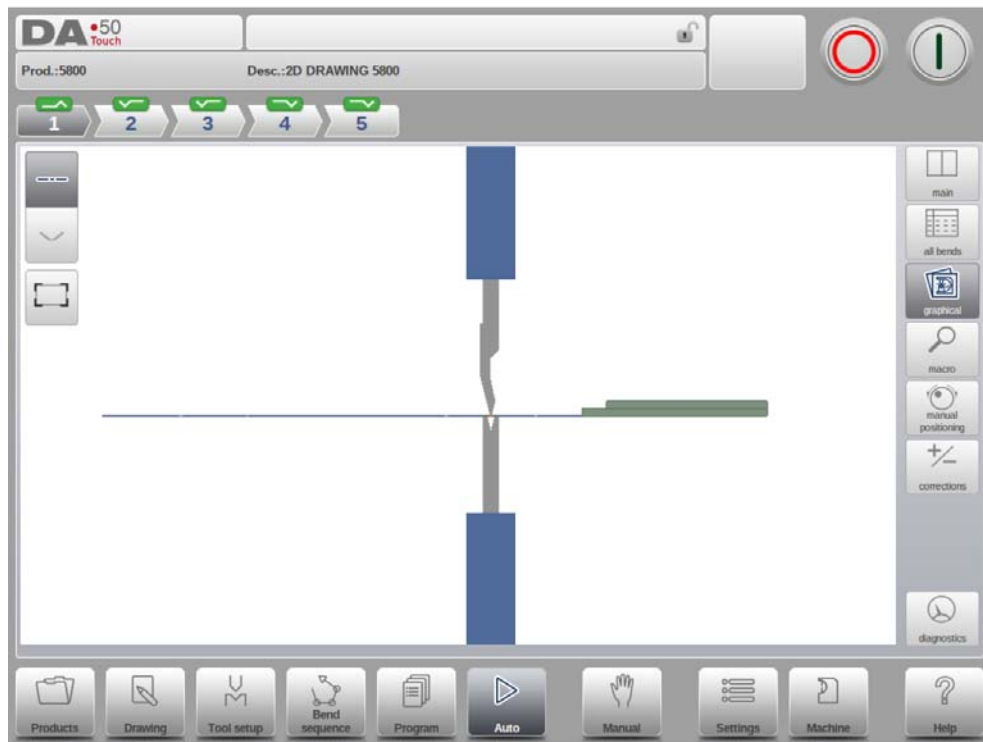

---

## 7.2.4. Macro

With macro view mode, the control switches to a view with only large axes values on the screen. This view can be used when working a little remote from the control, still able to read the axes values.

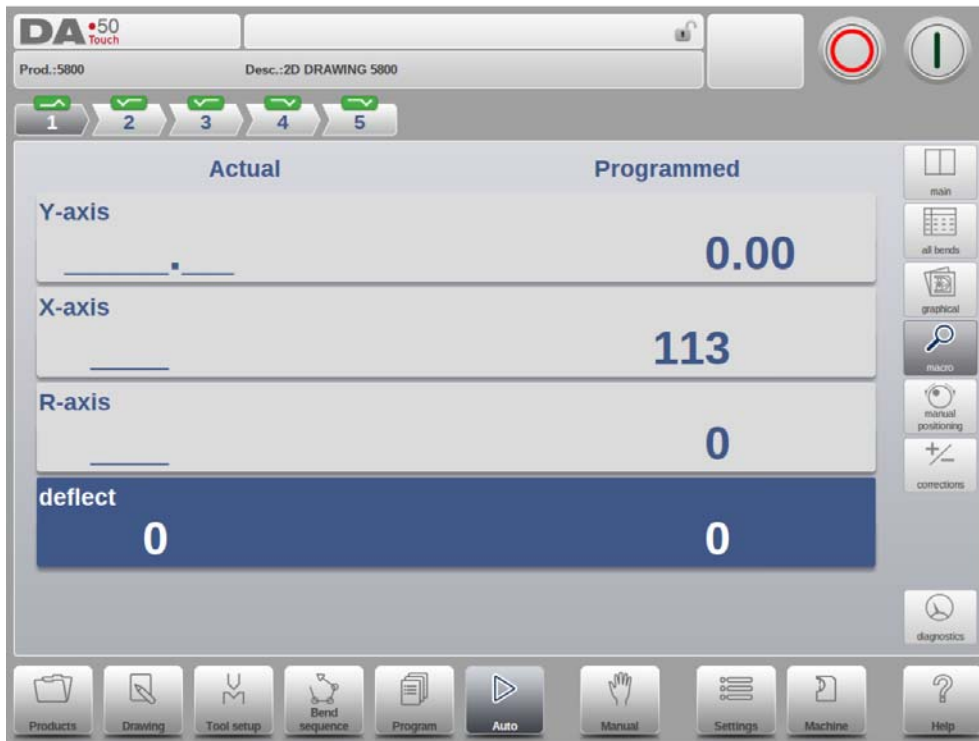

Next to the target position (programmed) also the actual position of all access can be followed.

## 7.2.5. Manual positioning

In manual positioning view mode the axes values are shown at large. Axes can be selected and while selected the position can be controlled by moving the slider, on the bottom of the screen, out of its middle position. When releasing the slider it will automatically return to its middle position.

The teach indicator:



When the teach indicators arrow is pressed, standing in between actual value and programmed value, the value is taught to the program step.

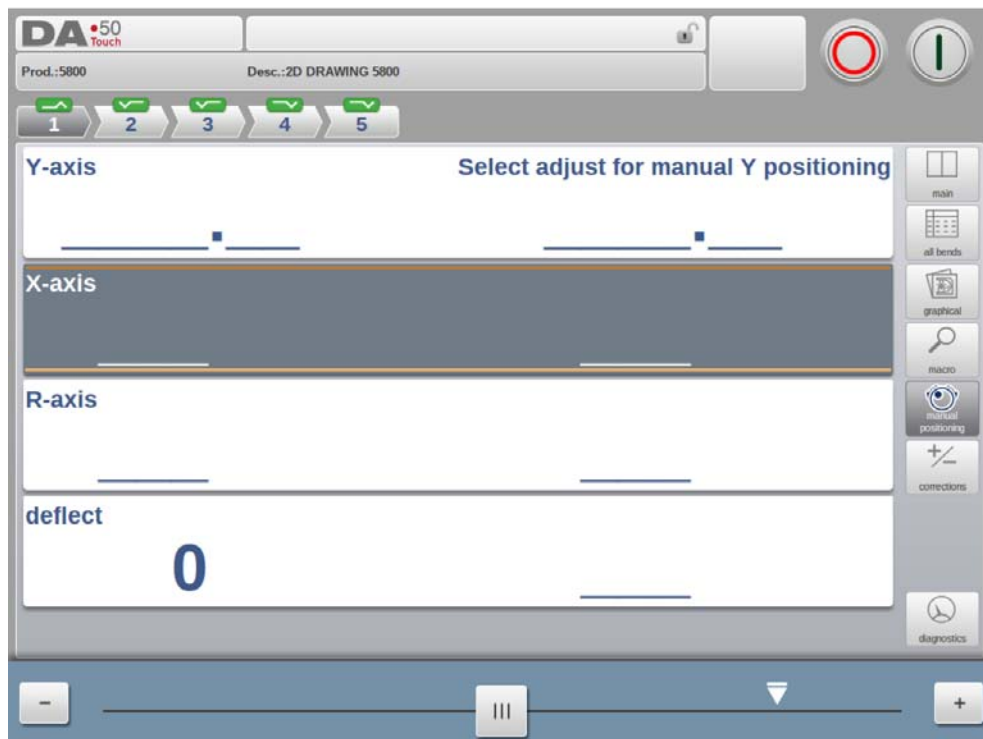

---

## 7.2.6. Corrections

In this view mode all corrections of all bends are shown. You can browse through all corrections and change them as you see fit. If a correction for  $\alpha_1$  is entered then this value is copied to the correction for  $\alpha_2$ . Different corrections for  $\alpha_2$  can be entered in the field itself.

Bend	Angle	Gen. corr. $\alpha$	Corr. $\alpha_1$	Corr. $\alpha_2$	Stored correction	G-corr. X	Corr. X-axis
1	90.00	0.00	0.00	0.00		0	0
2	135.00	0.00	0.00	0.00		0	0
3	90.00	0.00	0.00	0.00		0	0
4	90.00	0.00	0.00	0.00		0	0
5	90.00	0.00	0.00	0.00		0	0

The column 'Stored correction' is only available when the Angle correction database has been activated. When activated, the column 'Stored correction' shows for each bend the correction value that is present in the database. A blank entry in this column means the database does not have a correction value for this type of bend. When a new correction is entered, it will be copied to the database automatically.

The markers '>' indicate bends that have the same value.

All From Stored serves to copy corrections in the database to the current program: corrections in all bends are adjusted according to database values.

### Bend Allowance

The function Bend Allowance helps the user to add entries to the bend allowance table in case this is active. Based on the active bend parameters only the bend allowance corrections need to be entered before adding. When the measured value is given, this will result in a calculated bend allowance, derived from the difference between the programmed value and the measured value. To enable the bend allowance table go to the Settings mode.

## Calculate corrections, programming of measured angles

To calculate the corrections from measured angle values, one can use the “calculate corrections” function in the correction window. Calculate corrections will open a separate window in which, upon choice, the measured angle(s) can be programmed.

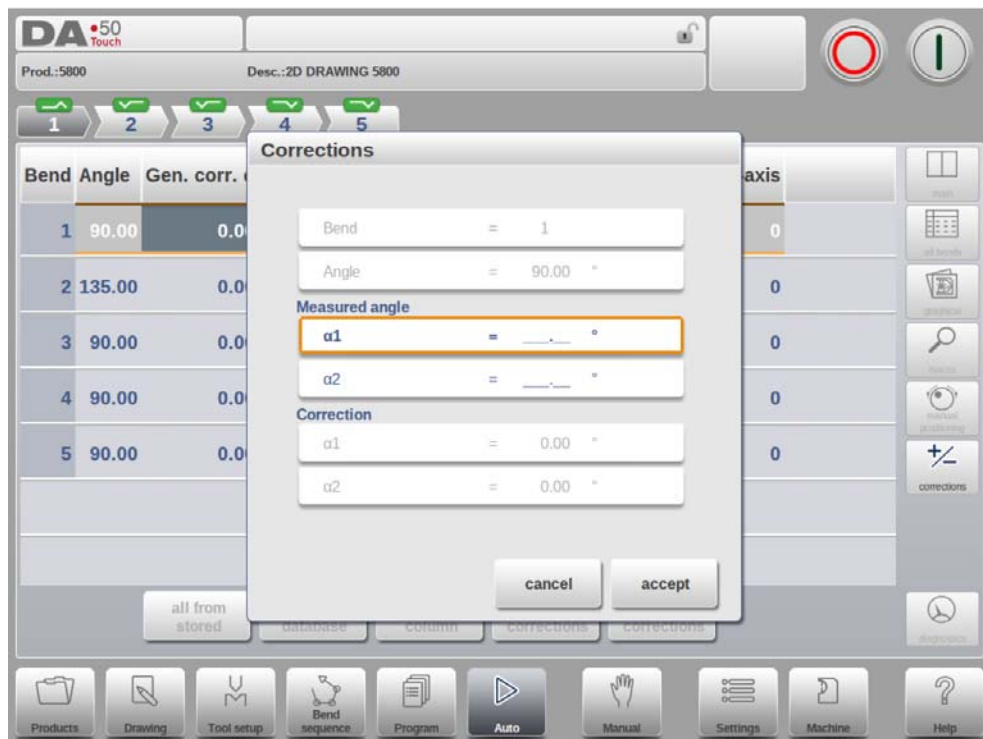

From the programmed value the control will determine a correction. The proposed result can be seen in the window itself. In the top of the window the programmed angle is shown, in the bottom of the window the resulting corrections are shown. When selecting accept, these values will be transferred to the main corrections screen.

When only one measured angle value is entered, the other values will be copied equally. If there are separate left, right or even middle values, these can be entered as well. The appropriate correction values will be determined from the entered values. The middle measured angle, if applicable, is transferred to an absolute crowning correction.

When using the optional protractor device, measured values can be taken directly into the correction field or can also be obtained within the “calculate corrections” window. After a satisfactory measurement, corrections are transferred to the main corrections window. If values are entered directly in the correction field, new corrections are only accumulated after a new bend cycle.

Axes corrections can also be edited in the main screen. When there are multiple axes available this special view mode can be switched to for all axes corrections.

---

## 7.2.7. Diagnostics

The diagnostics view mode is meant for service purpose mostly. In diagnostics the activities of independent axes can be monitored. I/O on the control system can be followed. In rare situations this information can be helpful to diagnose operation during the bending proces.

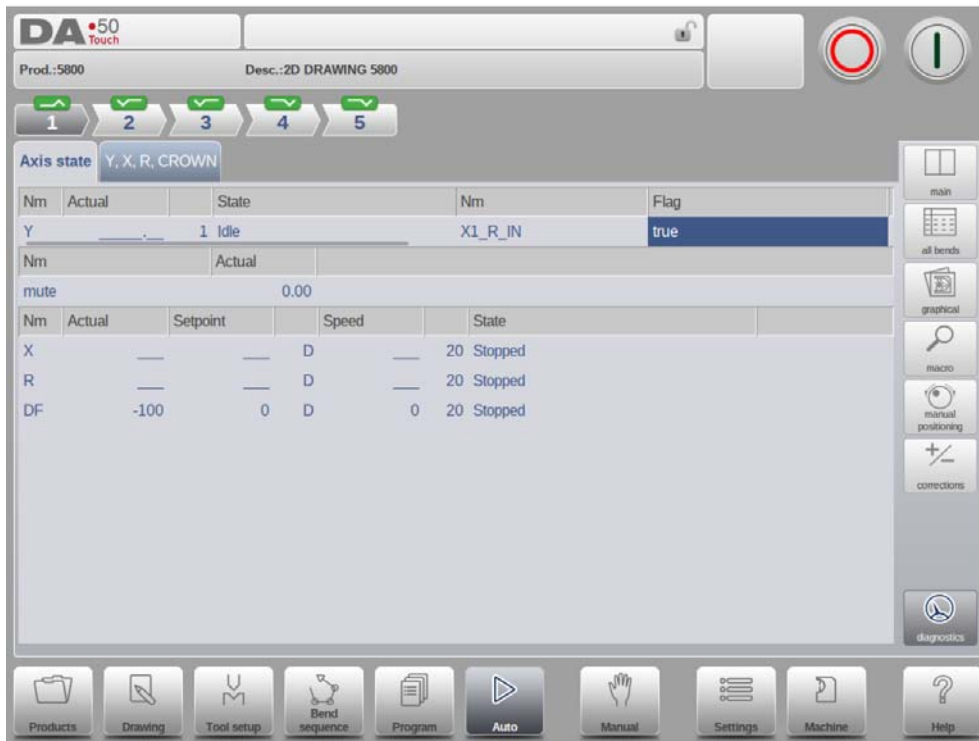

## 7.3. Bumping correction

In case of a selected bumping bend a general correction for a bumping bend can be entered. This function can be activated when the cursor is on the parameter for angle correction ('corr.  $\alpha1/\alpha2$ '). It is only available if a product is loaded that contains a bumping bend.

With Bumping Corr. a new window appears in which the correction can be entered.

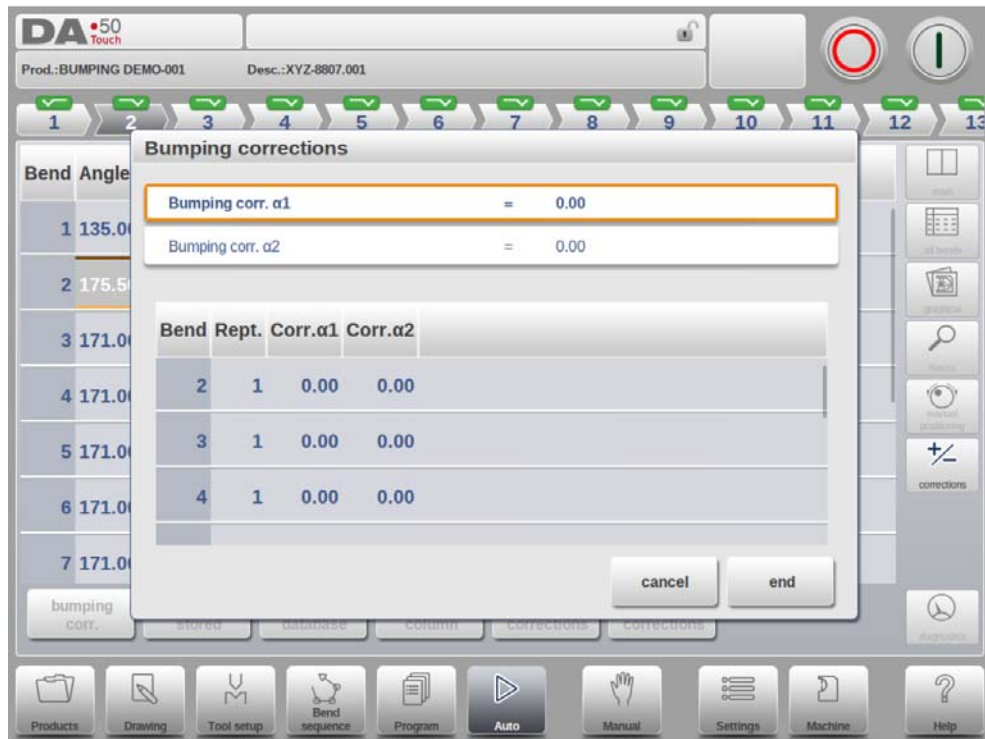

When the general correction of an angle is altered, all individual corrections are recalculated. When any of the individual corrections is altered, the general correction is recalculated. Bumping corrections can be programmed independently for both sides,  $\alpha1$  and  $\alpha2$ . When the general correction  $\alpha1$  is changed, it is automatically copied to  $\alpha2$  and as a result, all separate corrections for  $\alpha2$  are recalculated. To change correction values of  $\alpha2$ , use correction  $\alpha2$  or one of the separate corrections of  $\alpha2$ .

---

## 8. Manual mode

### 8.1. Introduction



By tapping the navigation button Manual the control is switched to the manual production mode.

In manual mode you program the parameters for one bending. This mode is useful for testing, for calibration and for single bends.

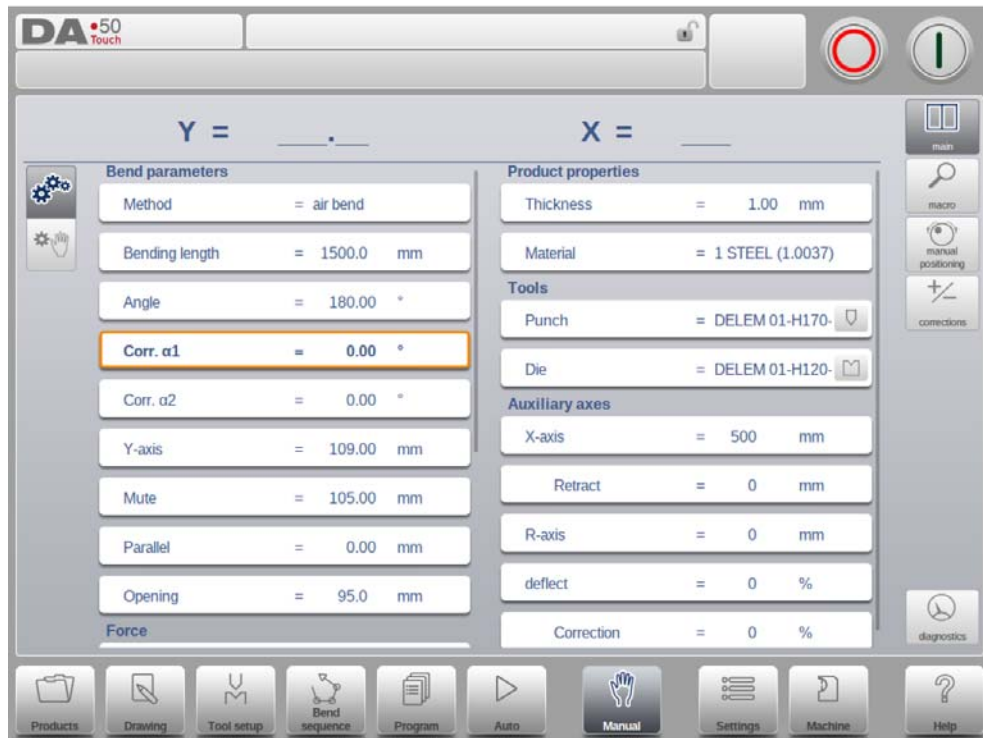

Manual mode is independent from Automatic mode and can be programmed independently of the programs in memory.

In the top of the Manual mode screen you can find the Y-axis and the main X-axis current position. All other axes and functions are listed one by one in the two columns below. When these Y axis value or the X-axis value is highlighted it means that the reference markers of these axes have been found and that they are positioned correctly referred to their programmed values.

---

### 8.1.1. Manual mode, parameter explanation

Following is a list of the available parameters in Manual mode.

#### Bend parameters

##### Method

Select the required bending method. The control supports 4 methods:

- Air bend
- Bottoming
- Hemming
- Hemming & bottoming



The bend methods have been explained in more detail on the Basic Data page in the Program mode.

##### Bending length

Program the bending length of the sheet.

##### Angle

Angle to bend.

##### Corr.α 1, Corr.α 2

Correction on angle to bend.

The angle correction should be entered as following examples indicate:

Programmed value of 90 degrees.

Measured value of 92 degrees.

-> Then it is required to program Corr.α with -2.

Programmed value of 90 degrees.

Measured value of 88 degrees.

-> Then it is required to program Corr.α with +2.

##### Corr.Y

Correction on the Y-axis position, in case bottoming has been selected.

##### Y-axis

The programmed or calculated Y-axis value to realise a certain angle.

##### Mute

Sequence point where the Y-axis is switched from fast closing speed to pressing speed. It is programmed here as a Y-axis position value. The programmed value is the Y-axis point above the sheet.

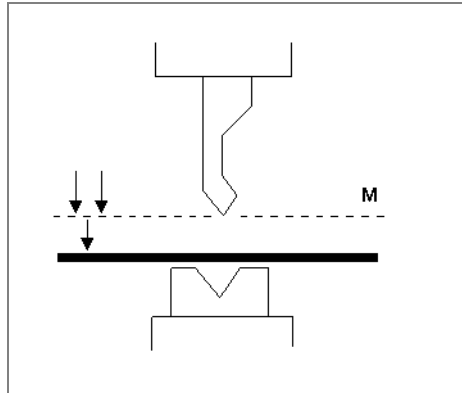

## Parallel

Difference of the left- and right hand side cylinder (Y1 and Y2). When positive, the right hand side is lower. When negative, the right hand side is higher. The programmed value is active below the clamping point.

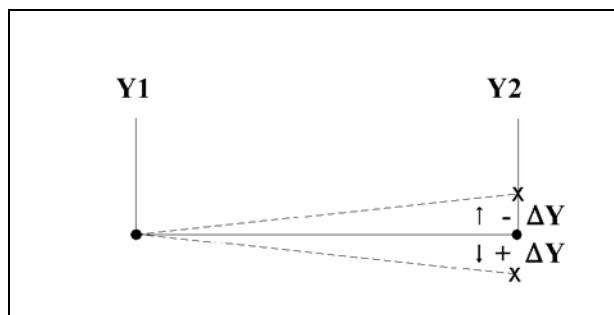

## Opening

This parameter results in a certain gap opening between the punch and the die after the bend. A positive value is the gap opening above Mute, a negative value below Mute. When you want to limit the handling time for the product you can program a small positive or a negative value.

## Hem opening

The hem bend can be made with a certain opening distance between the 2 flanges. The hem opening value will be used calculating the beam position in the hemming process. By default this parameter has the value of the Settings mode parameter Default Hem Opening.

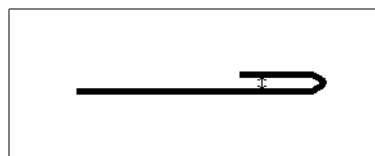

## Force

### Force

The programmed force applied during pressing.

---

**Dwell time**

Hold time of punch at the bending point.

**Decompression**

Decompression distance after the bending to release the working pressure from the system.

**Speed****Speed**

Pressing speed, the speed of the Y-axis during bending.

**Decomp speed**

The decompression speed is the programmable speed of the beam during the decompression stroke.

**Functions****Wait for retract**

In case of a retract, let the Y-axis wait until the retract is finished, yes or no.

No: the retract is started when the Y-axis passes the clamping point, the Y-axis does not stop.

Yes: when the Y-axis reaches the clamping point, the Y-axis is stopped and the retract is started. When the retract is completed, the Y-axis moves on.

**Product Properties****Thickness**

Program the thickness of the sheet.

**Material**

Selection of one of the programmed materials, which are used to calculate the bending depths. The control contains 4 pre-programmed materials. In total, 99 materials can be programmed on the control. The materials can be programmed on the Materials page in the Settings mode.

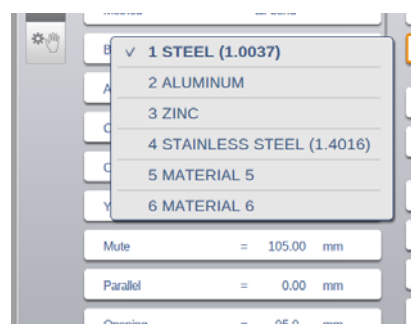
**Tools**

## Punch

The name (ID) of the selected punch. Tap to modify or select from the punch library.

## Die

The name (ID) of the selected die. Tap to modify or select from the die library.

The tool selection enables you to directly type the desired tool, or by tapping the list key on the keyboard, the library will be shown and a selection can be made. When typing, the filter function will narrow down your selection in order to rapidly find your tool.

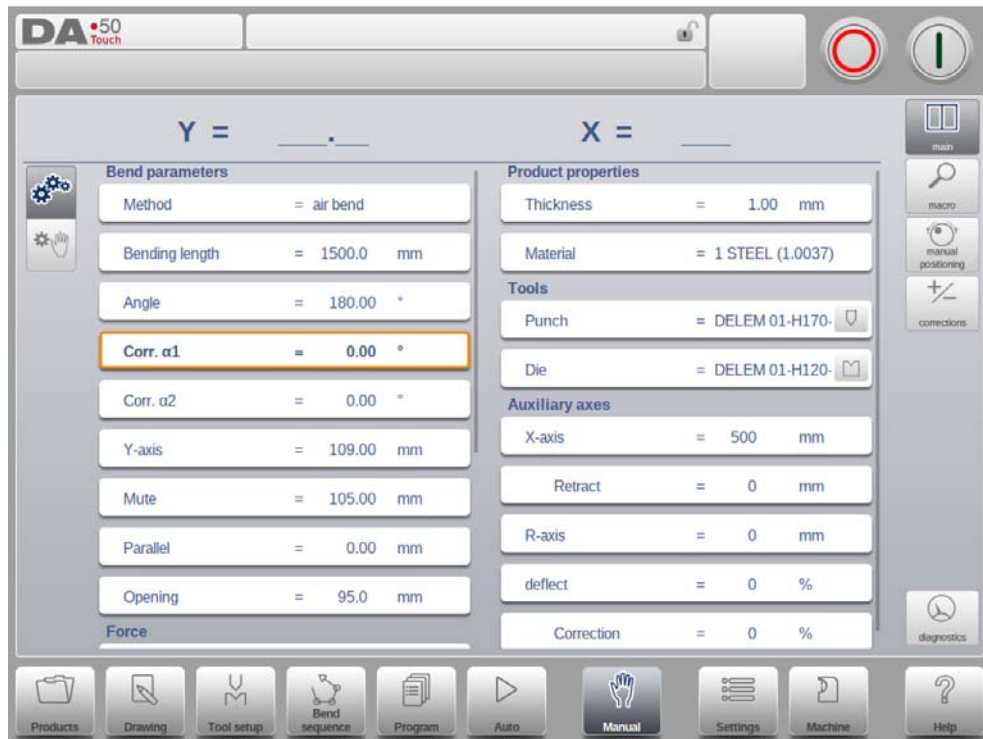

Turn Punch can be used to turn around the applied tool (back to front). When this is done, and active, the indicator is shown behind the punch or die.



## Gauges

### Auxiliary axis

If you have one or more auxiliary axes (for instance an X-axis, R-axis, Z-axis or part support) the parameters of these axes appear here. When you have a R1-axis and a R2 axis the programmed R1 value is automatically copied to the R2-axis value. The R2-axis value can, if necessary, be changed afterwards.

### Retract

The retract distance of the axis during the bend. The "backgauge retract" is started at the pinching point.

---

**Speed**

Speed of the axis in the current bend. Speed can be programmed in a percentage of the maximum possible speed.

The above mentioned parameters can be programmed and modified as required. After pushing the Start button the programmed parameters are active.

## 8.2. Programming parameters & Views

Parameters in manual mode can be programmed one by one. The effect of the parameter on other parameters can be computed either automatically or manually. This depends on the selected mode on the left-hand side of the screen. The Auto Computation switch enable to select between:



Automatic, effect of parameters on other parameters is automatically computed.



Manual, effect of parameters on other parameters is only effected by over entering and accepting the proposed values.

The relation between parameters is visualized with a symbol and a background color.

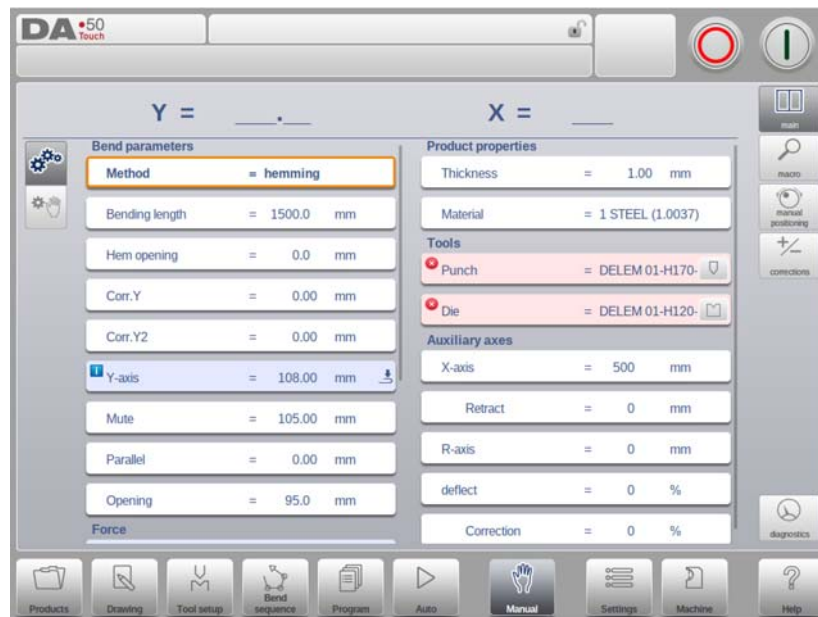

When an information symbol is shown with parameters after an edited value, this parameters was changed due to the last changed input.



A star symbol is shown with parameters if the value of the parameter differs from the calculated value by the control. This can be helpfull if a value is intentionally programmed different or if the value of a parameter is limited by the parameters limits.



An error symbol is shown with a parameters if the value cannot be correct according to the currently programmed values. This, eg. when a hemming bend is programmed with no

hemming tools programmed.

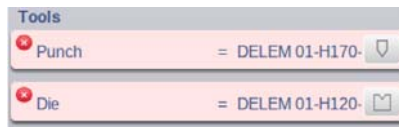

## View

The command buttons on the right side of the screen give access to other views. Next to the Main view, there are Macro, Manual Positioning, Corrections as also a Diagnostics view.

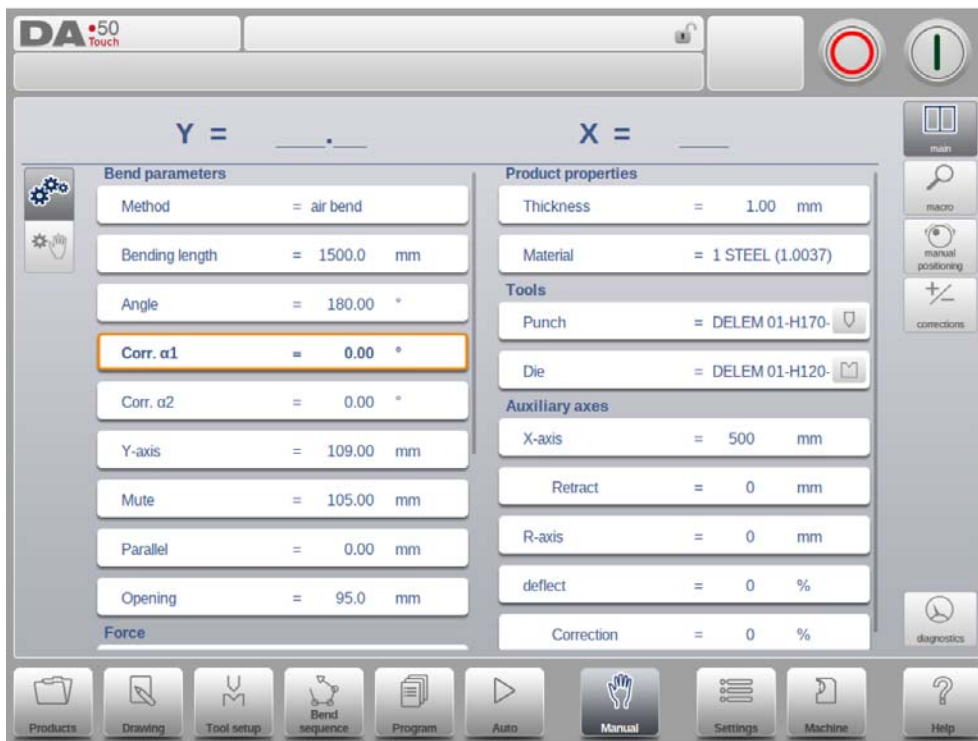

## 8.3. Macro

With Macro the control switches to a new view with only large axes values on the screen. This view can be used when working a little remote from the control, still able to read the axes values.

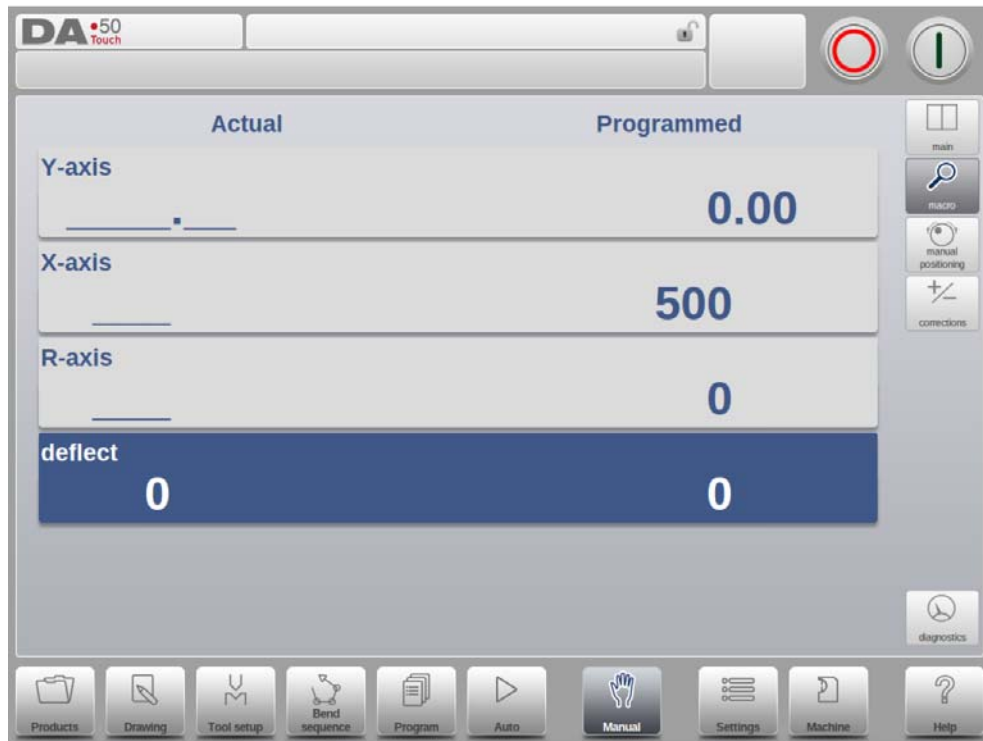

---

## 8.4. Manual movement of the axes

### 8.4.1. Movement procedure

To move an axis to a specific position manually, the slider at the bottom of the screen, can be used. After tapping Manual Pos in the main screen of Manual Mode, the following screen appears:

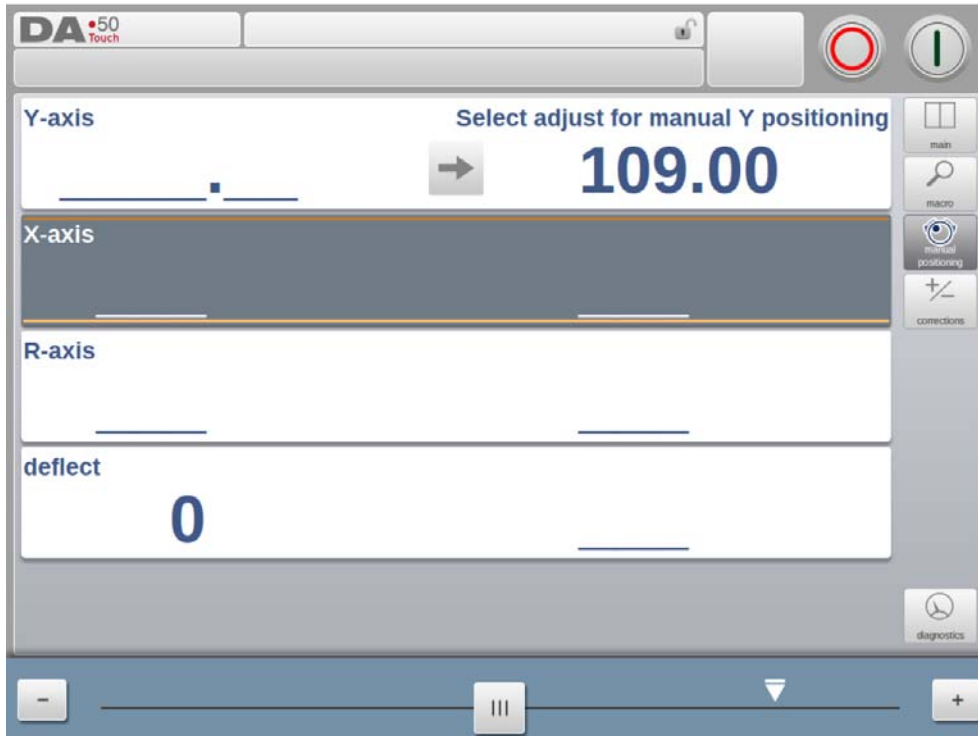

Within this mode, any of the shown axes can be moved by moving the slider out of its middle position. The procedure for moving the axis depends on the axis you wish to move. When releasing the slider it will automatically return to its middle position.

#### Auxiliary axes

The control must be stopped.

First select the desired back gauge axis, you will see the cursor at the required axis. Then you can move the axis by moving the slider.

#### Y-axis

The pressbeam can be positioned manually in the same way as the auxiliary axes. However, for the Y-axis several conditions must be met:

- The control must be started.
- The 'adjust' function must be active. If this function is not active a message is shown in the upper right-hand corner.
- The Y-axis must be below mute-point.
- A pressing command must be given to the CNC.

## 8.4.2. Teach

To teach the control, taking over a position found by manual moving an axis, a simple procedure can be used.

When you have moved an axis to a certain position with the slider, you may want to store this position. To do so, tap the axis name in the Programmed column. The actual axis value (left side) will appear in the programmed axis field (right side).



When you return to the standard screen of manual mode, the axis parameter will have the recently taught value.

---

## 8.5. Corrections

In this view mode the corrections for the bend programmed in Manual mode are shown. Since this is always a single bend, a single line will be shown.

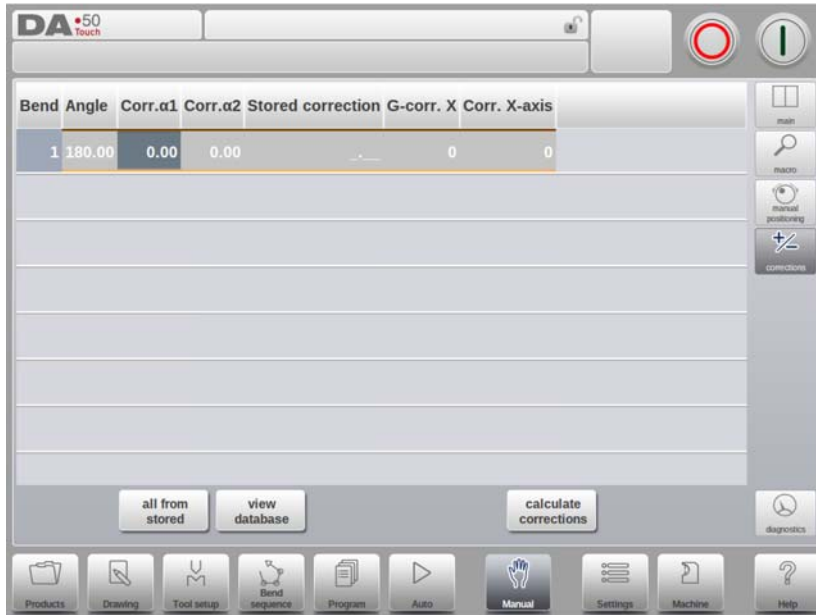

The programmed corrections can be verified here similarly to the corrections in Automode. Entries in the correction database and for initial correction can also be monitored in this screen. Since these are of significant influence on the bend result, access to the database can be used to modify. This can also be useful while finding appropriate corrections with testbending and storing the found results in the database.

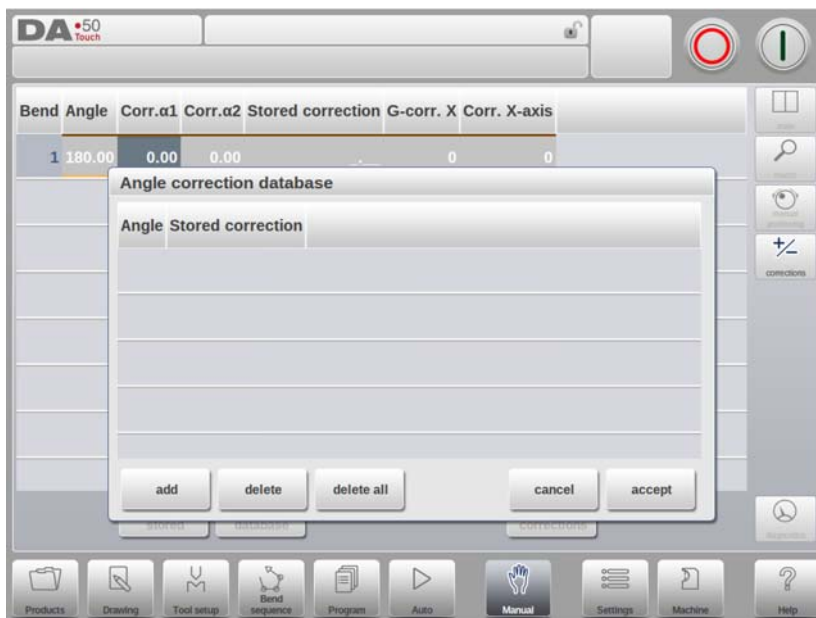

## **Bend Allowance**

The function Bend Allowance helps the user to add entries to the bend allowance table in case this is active. Based on the active bend parameters only the bend allowance corrections need to be entered before adding. When the measured value is given, this will result in a calculated bend allowance, derived from the difference between the programmed value and the measured value. To enable the bend allowance table go to the Settings mode.

---

## 8.6. Diagnostics

When tapping Diagnostics, the control switches to a new view which shows axes states. In this window, the current state of available axes can be observed. This screen can also be active while the control is started. As such, it can be used to monitor the control behaviour during a bend cycle.

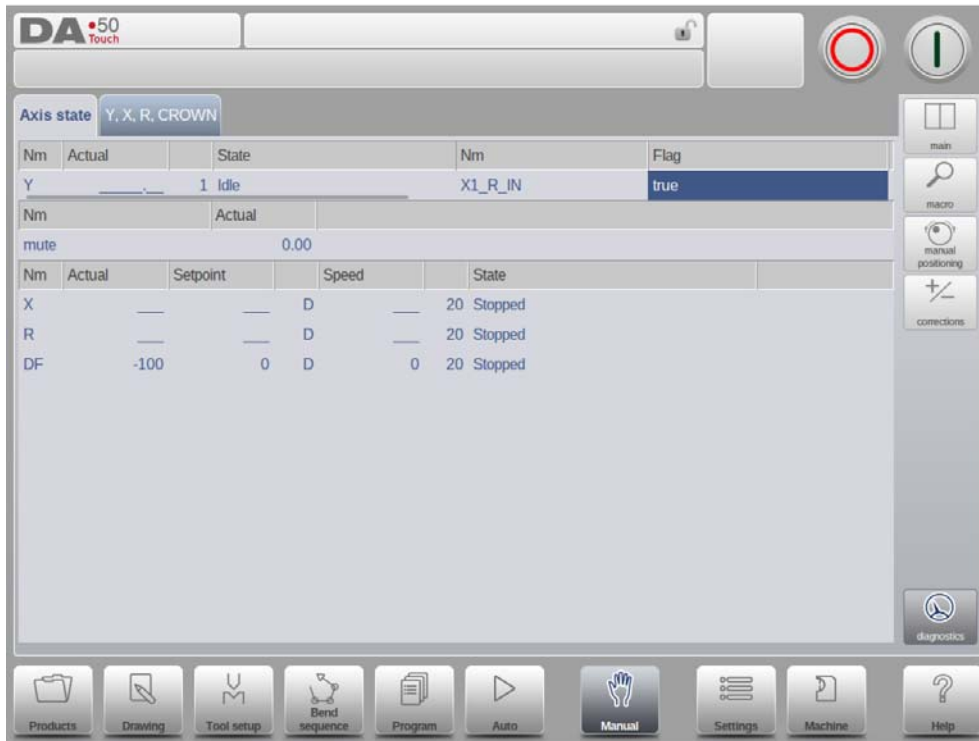

## 8.6.1. IO status

When tapping on the I/O tab the Diagnostics, the control switches to a new view with the state of inputs and outputs. In this window, the current state of inputs and outputs can be observed. This screen can also be active while the control is started. As such, it can be used to monitor the control behaviour during a bend cycle.

The screenshot shows the 'IO status' screen in the DA 50 Touch control interface. The screen displays a table with 32 rows of data, each representing an I/O point. The table is organized into four columns, each with a 'Pin #', 'Value', and 'Description'. The 'Value' column indicates the current state of the I/O point (0 for off/low, 1 for on/high). The 'Description' column provides the name of the I/O point. The interface also includes a top navigation bar with 'Axis state' and 'Y, X, R, CROWN' tabs, a right-side vertical menu with icons for 'main', 'macro', 'manual positioning', 'connections', and 'diagnostics', and a bottom horizontal menu with icons for 'Products', 'Drawing', 'Tool setup', 'Bend sequence', 'Program', 'Auto', 'Manual', 'Settings', 'Machine', and 'Help'.

Pin #	Value	Description	Pin #	Value	Description	Pin #	Value	Description	Pin #	Value	Description
1	0	KEY_LOCK	9	0	Y_UDP	17	0	Y_MUTE2	25	1	X_OK
2	0	FD1_1	10	0	Y_ER	18	0	Y_CLAMP	26	1	X_IP
3	0	CR-	11	0	Y_MUTE	19	0	Y_LDP	27	1	R_OK
4	0	CR+	12	0	NC_START	20	0	C_NCRDY	28	1	R_IP
5	0	FD1_4	13	0	Y_OPEN	21	0	Y_T	29	1	X_START
6	0	FD2_1	14	0	Y_PRESS	22	0	Y_C	30	1	X_RSD
7	0	FD2_2	15	0	Y_MANUAL	23	0	Y_CLOSING	31	1	R_START
8	0	FD2_3	16	0	Y_PAR_SW	24	0	Y_PUMP_S	32	1	R_RSD

---

## Zoomed IO

When tapping on one or more (up to 8) pins and extra page Zoomed IO is created with an enlarged view of the selected IO; selected pins will be shown in large, enabling distant monitoring.



## 9. Settings

### 9.1. Introduction



By tapping the navigation button Settings the control is switched to Settings mode.

The Settings mode of the control, which can be found in the navigation panel, gives access to all kind of settings which influence the programming of new products and programs. Default values and specific constraints can be set.

The settings are divided across several tabs logically organizing the different subjects. In the following sections the available tabs and detailed settings are discussed.

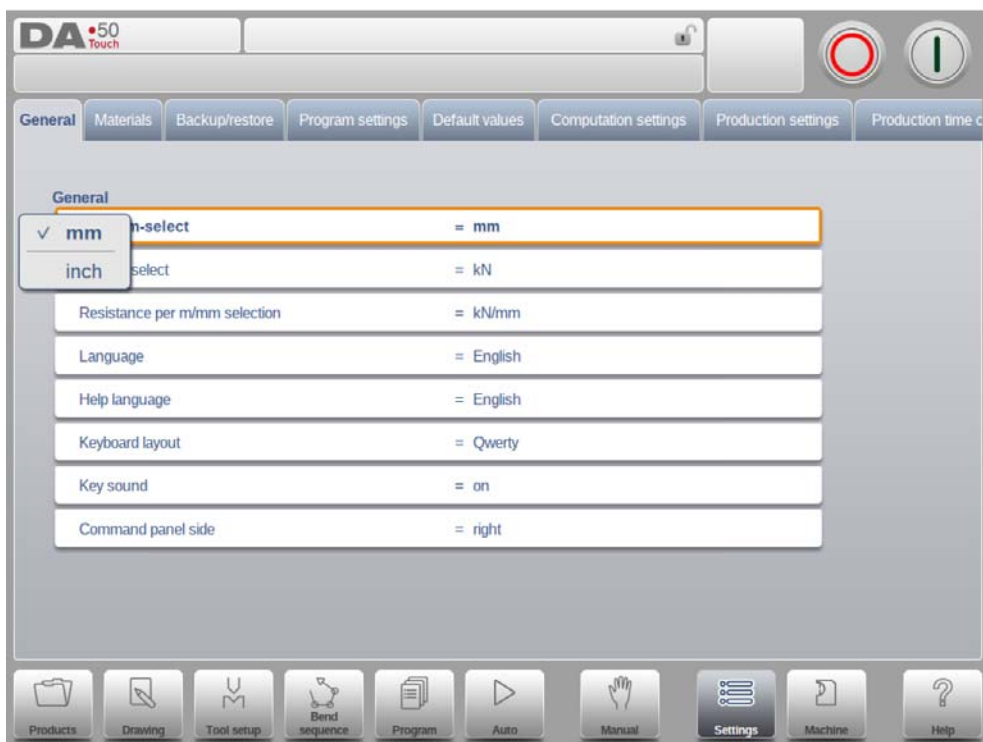

Navigation through the tabs can be done by just tapping them and selecting the required item to adjust. Since there can be more tabs than the screen can show in one view, dragging the tabs in horizontal direction enables to view and select all available tabs.

---

## 9.2. General

Select the required tab and tap the parameter to be changed. When parameters have a numerical or alphanumerical value, the keyboard will appear to enter the desired value. When the setting or parameter can be selected from a list, the list will appear and selection can be done by tapping. Longer lists allow scrolling vertically to check the available items.

### Inch/mm-select

Select to use either Millimeters or Inches as the unit to be used.

### Ton/kN select

Select to use either Ton or kN as the main unit to be used for all force data.

### Resistance per m/mm selection

Select to use the resistance either per meter or per millimeter.

### Language

The user interface language can be selected from the list. There are more available languages than initially shown. Scroll vertically by dragging the list up and down to see all available languages. Tap to select the desired language for the user interface.  
(For languages using special, non standard alphanumerical characters, the control will reboot.)

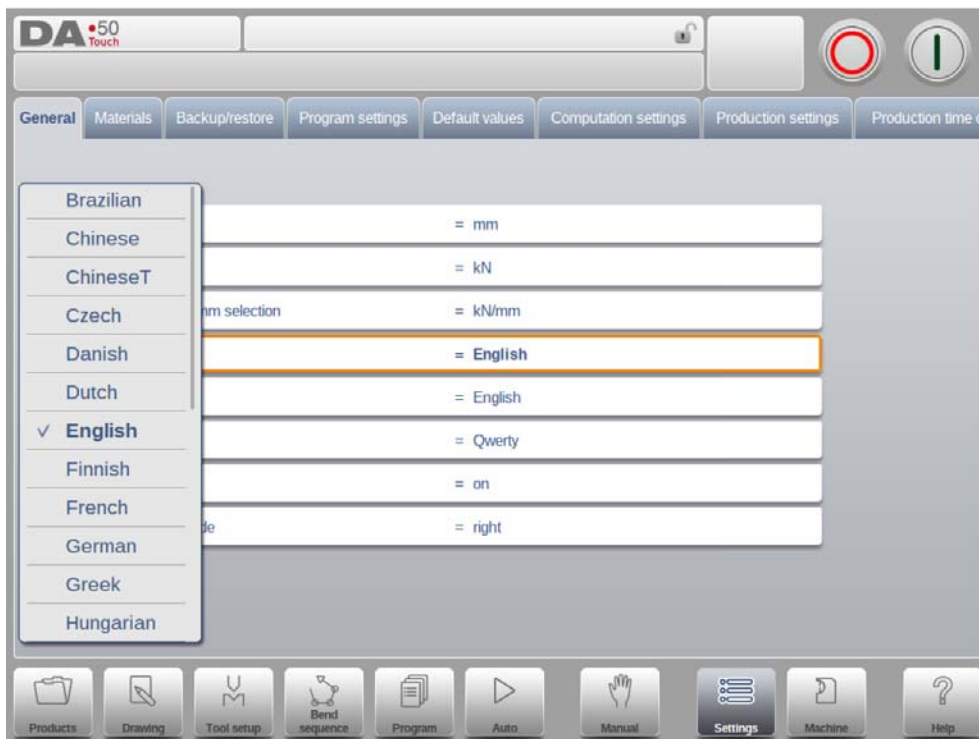

### Help language

The help language for the on-line Help function is by default set to the same language as the user interface. If that language is not available as on-line Help, English is chosen.

When Help Language is selected, the additional function Add Help Language appears.

With this function you can install a new help language on the control. Make sure the required help file is present on the control disk or another accessible location (network, USB stick). It will automatically be selected and installed.

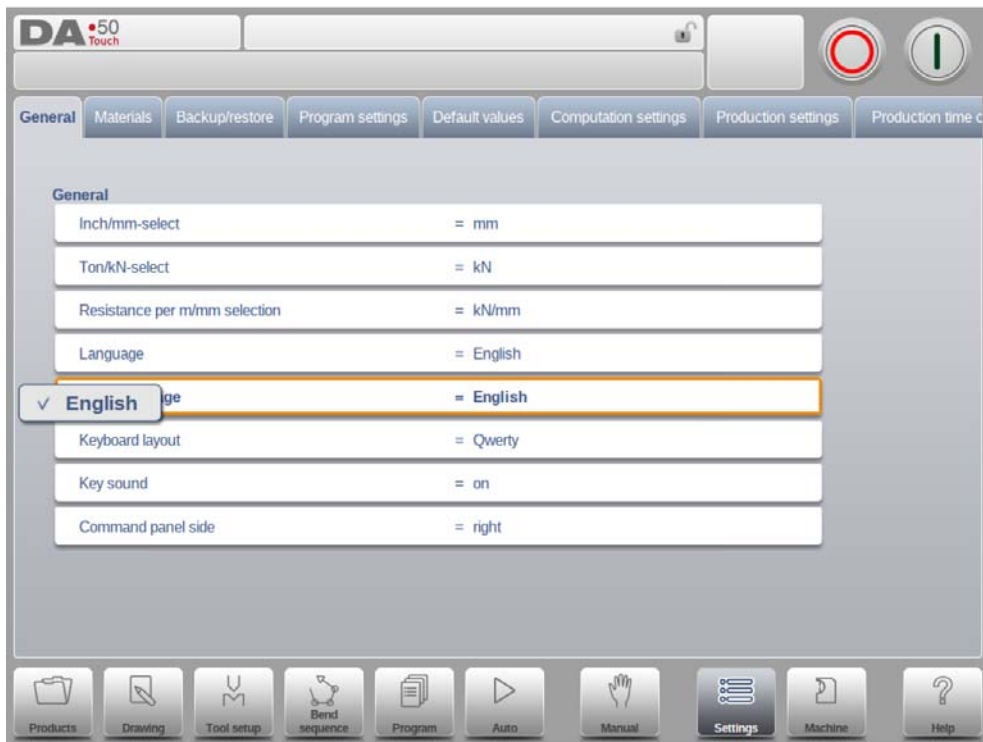

### Keyboard layout

Upon choice one can select Qwerty, Qwertz or Azerty keyboard layout. Default layout is Query.

### Key sound

Switch the sound function of the input panel on or off. Default sound is on.

### Command panel side

Switch the command panel to the left side of the screen. Default is right side.

---

### 9.3. Materials

In this tab, materials with their properties can be programmed. Existing materials can be edited, new materials can be added or existing materials deleted. A maximum of 99 materials can be programmed on the control.

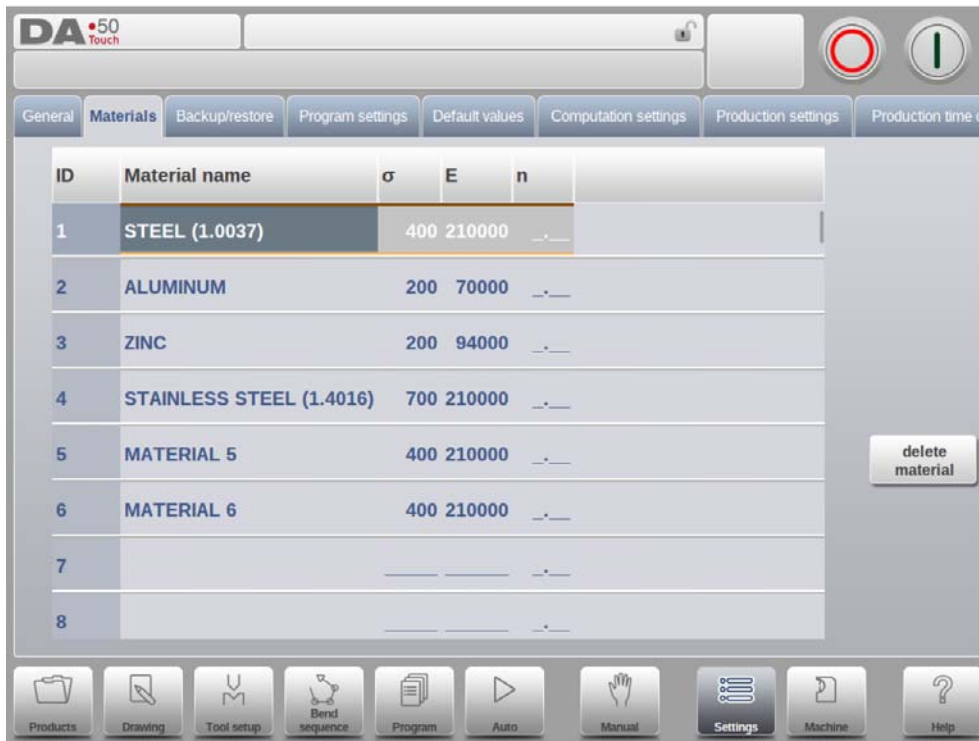

For each material, three properties are present and can be viewed and edited.

#### Material name

Name of the material, as it will appear in the programming screens. The maximum allowed length of the material name is 25 characters, the name must begin with a character (not a numeral).

#### Tensile strength

Tensile strength of the selected material.

#### E module

E-module of the selected material.

The materials are initially listed according to their material number, which is shown in the first column (ID). The list can be sorted according to the different properties by tapping the title of the column. The materials will be sorted in ascending or descending order of that property.

To change an existing material, select the relevant line and change the values as you see fit. To delete an existing material, select the relevant line and use Delete Material. This will erase the values.

To program a new material select an empty line and start programming its values.

## 9.4. Backup / restore

This tab offers the possibilities to backup and restore products, tools as well as settings and tables. When products or tools originate from older control models, both for products and tools an import function can also be found here.

Tools and products can be backed up and restored according to the following procedures. The procedures for saving or reading data are similar for all types of backup media: e.g. network or USB stick.

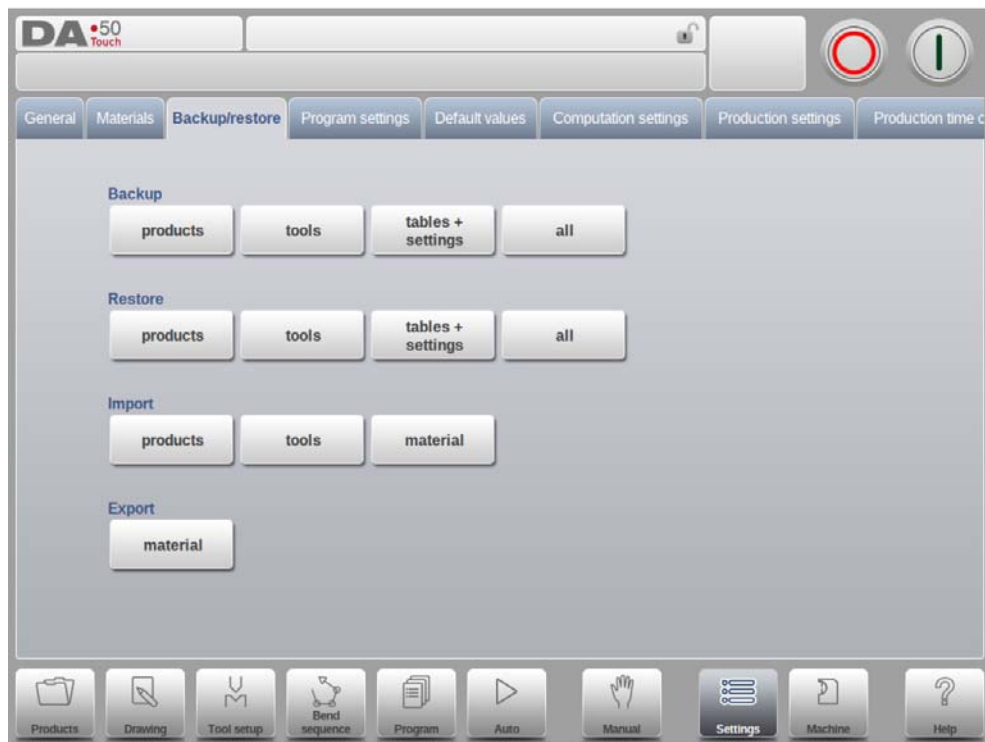

The actual backup directory consists of a device (USB stick, network) and a directory. The choice of devices depends on which devices are connected to the control. If necessary, directories can be created and selected. The backup locations for storage of products and tools are set independently.

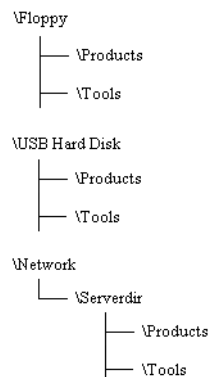

---

### 9.4.1. Product backup

To make a backup of programs to disk, choose 'products' in the Backup section on the Backup/restore page.



When the initial backup directory has been set, the products backup screen appears.

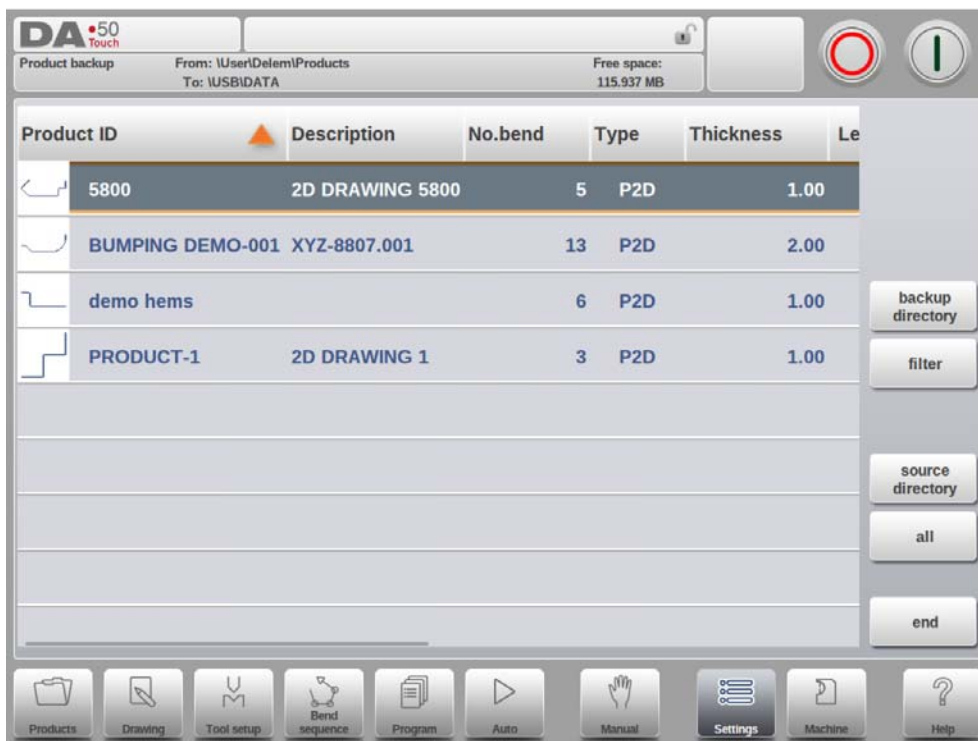

In the backup screen the products in the selected directory are shown. Basic functions to change the view can be chosen similarly to the Products mode. This enables to easily find the required products to be backed up.

At the top of the screen, the current source location is shown as well as the backup location. To backup a product, select it by tapping, in the list. The backup marker will appear to confirm the backup action. If a product file with the same name is present on the backup location, a question is offered whether or not to replace that file. To backup all products at once, tap All.

The source where the products are located which have to be backed up can be changed with Source Directory. The directory browser appears and the desired source directory can be navigated to.

The directory where the products which need to be backed up need to go can be changed as well. With Backup Directory the directory browser appears and the desired destination directory can be navigated to.

## 9.4.2. Product restore

To restore programs to the control, choose 'products' in the Restore section on the Backup/restore page.



When the initial restore directory has been set, the products restore screen appears.

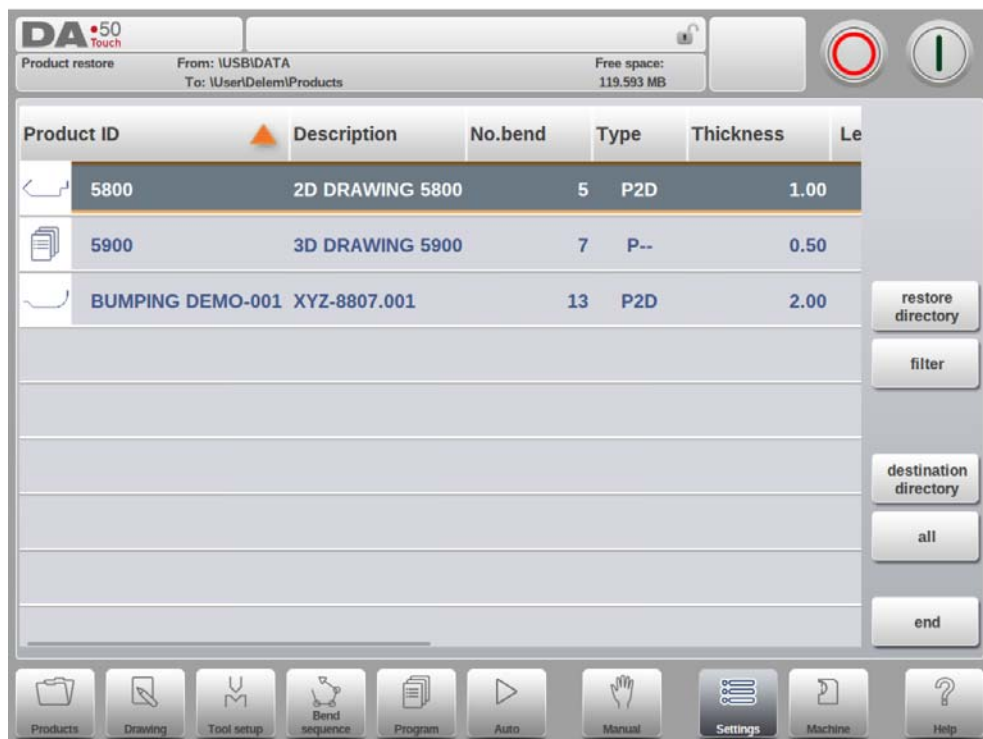

In the restore screen the products in the selected directory are shown. Basic functions to change the view can be chosen similarly to the Products mode. This enables to easily find the required products to be restored.

At the top of the screen, the current restore source location is shown as well as the location on the control to restore to. To restore a product, select it by tapping, in the list. The restore marker will appear to confirm the restore action. If a product file with the same name is present on the control, a question is offered whether or not to replace that file.

The source location where the products to be restored are coming from can be changed with Restore Directory. The directory browser appears and the desired restore directory can be navigated to.

The directory where the products which need to be restored need to go can be changed as well. With Destination Directory the directory browser appears and the desired destination directory can be navigated to.

---

### 9.4.3. Tool backup

To make a backup of tools to disk, choose 'tools' in the Backup section on the Backup/restore page.



When the initial backup directory has been set, the tools backup screen appears.

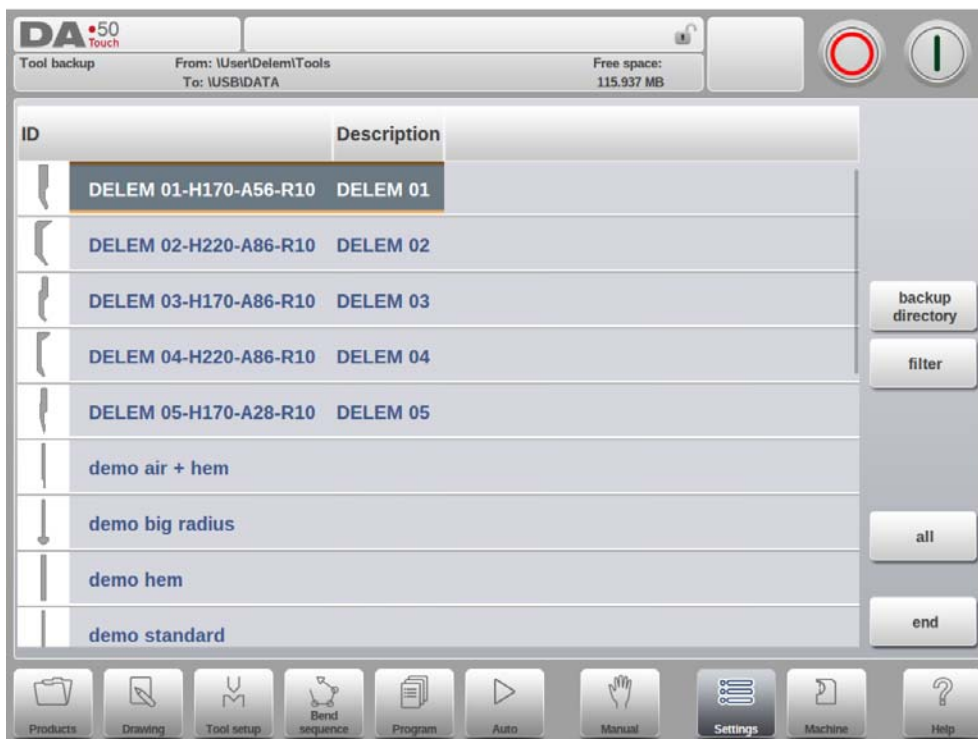

With this menu a back-up of tools on the control can be made: punches, dies or machine shapes. The procedures for a tool back-up run similar to the procedures for a product back-up.

#### **9.4.4. Tool restore**

The restore procedures for tools run similar to the procedures for product restore.

#### **9.4.5. Backup and restore for Tables and Settings**

To backup user specific settings and tables the Backup/restore tab offers specific functionality. The procedure is again analogue to the backup and restore of products and tools. The special function All, will automatically execute all steps sequentially for either Backup or Restore (Products + Tools + Tables + Settings).

---

## 9.4.6. Directory navigation

When Backup Directory is used, a new window appears with a list of available backup directories.

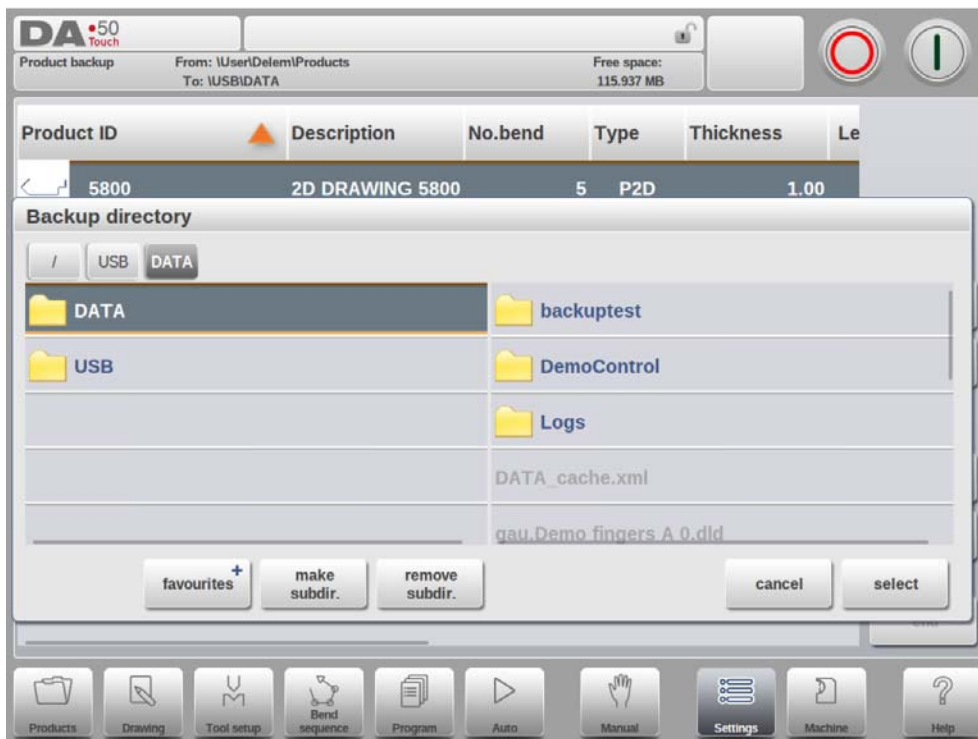

In this window you can browse through the directory structure of your backup device. Tap the dot to look inside a subdirectory. To move one level up, tap the (PARENT) map. To select the directory you are currently in, tap Select.

To change from one device to another, tap the (PARENT) symbol a number of times until the highest level is reached. From there, select the proper device and choose the correct subdirectory.

If a network connection is available you must first select Network and subsequently one of the offered network volumes. After that it works similar to other devices.

You can make new subdirectories or delete existing ones tapping Make Subdir and Remove Subdir. If there are subdirectories present, just tap it to move to the required directory and tap Select to select it.

## 9.5. Program settings

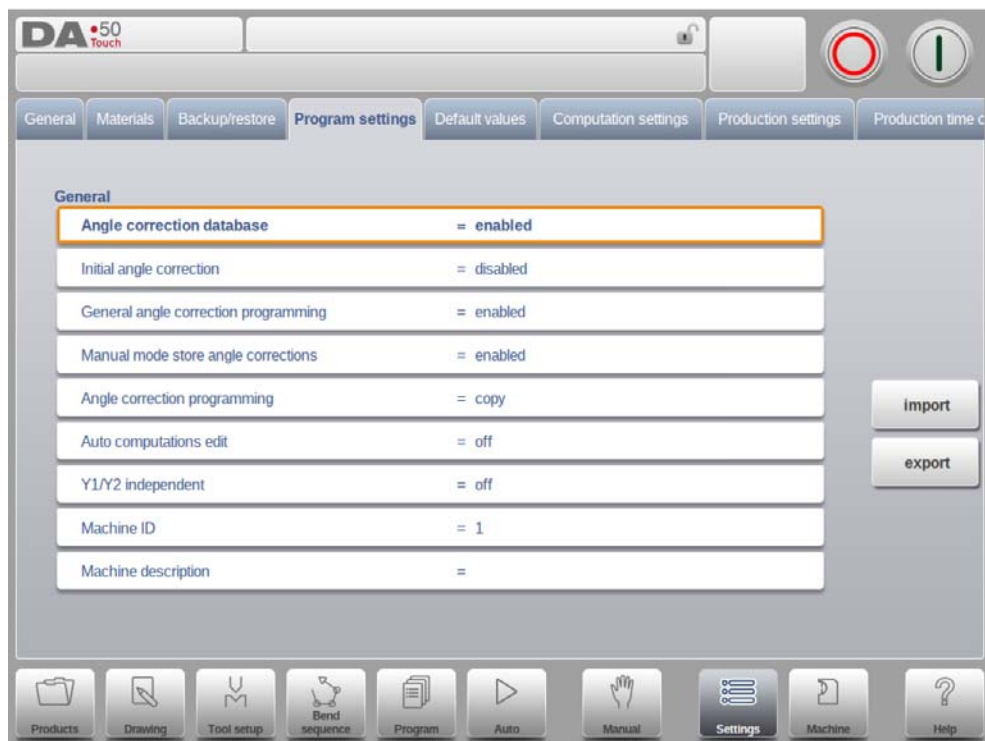

### Angle correction database

Parameter to enable the database with angle corrections.

Angle corrections are entered in production mode (Auto mode). These corrections are stored in the product program.

The Angle correction database enables the possibility to store these corrections in a database. In this way corrections that have once been entered for certain bends remain available for future use in other products.

With this setting enabled, the control checks during production whether corrections for similar bends are present in the database. If corrections for certain bends are available, then they will be offered. On other occasions, corrections can be interpolated and offered.

The correction database is adjusted by entering new corrections during production. When the database is enabled with this parameter, all new-entered corrections are stored in the database.

When searching for similar bends, the control searches for bends that have the same properties as the active bend. The following properties of a bend are compared:

- Material properties
- Thickness
- Die opening
- Die radius
- Punch radius
- Angle

The first five properties of a bend must be exactly the same as the active bend to start a

---

comparison. If the angle is the same as the angle of the active bend, the correction is offered. If the angle of the active bend has a maximum difference of 10° with two adjacent bends, a correction is interpolated from these two bends. If the difference of the corrections of the two adjacent bends is more than 5°, there will be no correction offered.

### Initial angle correction

To program relative small angle corrections the initial correction database is available. This parameter is independent on the parameter "Angle correction database". The initial correction is only visible and programmable on the corrections page in automatic mode. On the main page in automatic mode the initial correction is not visualized. The total correction is the sum of the visualized correction and the initial correction.

Example:

- Program an angle correction of -8 degrees.
- Program an initial correction of -6 degrees. Now the total correction remains unchanged: the visualized correction is changed from -8 degrees to -2 degrees.

disabled => no initial angle corrections programmable.

enabled => initial angle corrections programmable in all corrections overview

### General angle correction programming

To program general angle corrections which are used in all bends of the program. These angle corrections are not related to specific bend angles and therefore not stored in the angle correction database.

disabled => no general angle corrections.

enabled => only G-corr.  $\alpha_1$  (default).

$\alpha_1$  and  $\alpha_2$  => G-corr.  $\alpha_1$  and G-corr.  $\alpha_2$ .

### Manual mode store angle corrections

To enable the storage of angle corrections programmed in Manual mode. Corrections can be derived from bend results in Manual mode which later can be used during product programming.

### Angle correction programming

Parameter to switch between copying or keeping the delta values or changing independently when changing angle corrections in production mode.

copy => copy  $C\alpha_1$  to  $C\alpha_2$  when changing  $C\alpha_1$  (default).

delta => keep delta between  $C\alpha_1$  and  $C\alpha_2$  when changing  $C\alpha_1$ .

independent => change  $C\alpha_1$  and  $C\alpha_2$  independently.

### Auto computations edit

In the Program mode you can change the value of the programmed parameters. This can also influence the value of other parameters. With this parameter set on you can choose to have the other values automatically recomputed.

There are three cases in which automatic computation can be used:

1. In case you change the value of the parameters 'material type' or 'material thickness' then the following parameters are automatically recomputed and changed by the control:

- Force

- Decompression distance
- Crowning device setting

2. In case you change the value of the parameter 'length' then the following parameters are automatically recomputed and changed by the control:

- Force
- Decompression distance
- Crowning device setting
- Z-axis position

3. In case you change the parameter 'punch' or 'die' and the height of the new punch or new die is different AND ONLY in case the 'bend method' is 'bottoming' or 'hemming' then the following parameter is automatically recomputed and changed by the control:

- Y-axis position ('bend position')

(When the 'bend method' is 'air bend' (normal situation) the Y-axis position is calculated in the automatic mode!)

If the Automatic computations edit is switched off (default situation) then these parameters stay the same. However, when you enter these parameters by tapping them the recomputed value is displayed. When you press 'enter' the recomputed value replaces the old value after all. So, you can choose to change the values.

### **Y1Y2 independent**

Parameter to program the two Y-axes independently.

- off => single Y-axis programming (default)
- on => program Y1 and Y2 separately

### **Machine ID**

When there are several bending machines in a factory, it can be useful to give the control on each machine a unique machine ID.

This ID will be checked when a program is read from a back-up medium. When the machine ID does not match you must confirm to read it anyway or not. If you do not confirm the question the action will be aborted.

### **Machine description**

The description as programmed here will only be used in the offline Profile-T to get an overview of the different machines available in the factory. With this information it will be more clear which machine is used in combination with this control.

---

## 9.6. Default values

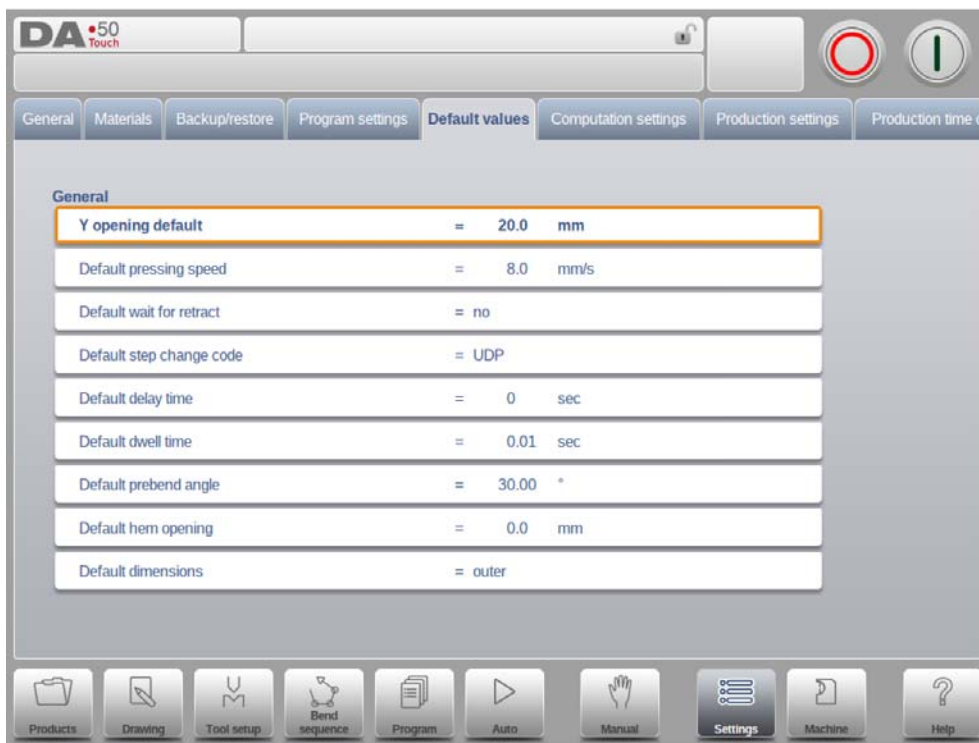

### Y opening default

Default Y-axis opening value.

The value programmed here is used as initial value for the parameter 'Y-axis opening' in the Program mode.

### Default pressing speed

Default pressing speed, used as initial value for the parameter 'pressing speed' in a new program.

### Default wait for retract

Default value for the parameter 'wait for retract' in a bend program. This parameter determines the control behaviour in a bend program. Initially the parameter 'wait for retract' is set to the value programmed here during postprocessing and during programming.

The default value of this parameter: yes.

### Default step change code

Default value for the parameter 'step change code' in a bend program. This parameter determines the moment of step change in a bend program. Initially the code parameter is set to the value programmed here during postprocessing and during programming.

The default value of this parameter is: UDP.

The step change codes have been explained in more detail on the Optional Data page in the Program mode.

### Default delay time

During the postprocessing, the waiting time of the X-axis at step change is set to zero.

With this parameter you can preset a longer waiting time when needed for product handling.

**Default dwell time**

Default value for the parameter 'dwell time' in a bend program.

**Default prebend angle**

Default value for the parameter 'prebend angle' in a graphical product.

**Default hem opening**

The hem bend can be made with a certain opening distance between the 2 flanges. The hem opening value will be used calculating the beam position in the hemming process. This programmed default value will be used when programming the product with hem bend graphically in the Drawing mode or by programming a new program in the Program mode. The starting value is 0.0mm to get the two flanges of a hem bend completely upon each other without any space between the flanges. The default value of the parameter = 0.00

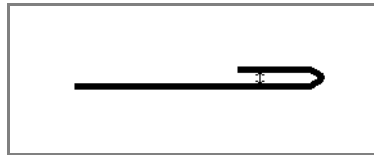
**Default dimensions**

A graphical product drawing can be made in outside or inside dimensions. This parameter defines the default value of the parameter "dimensions (D1)" when creating a graphical drawing.

---

## 9.7. Computation settings

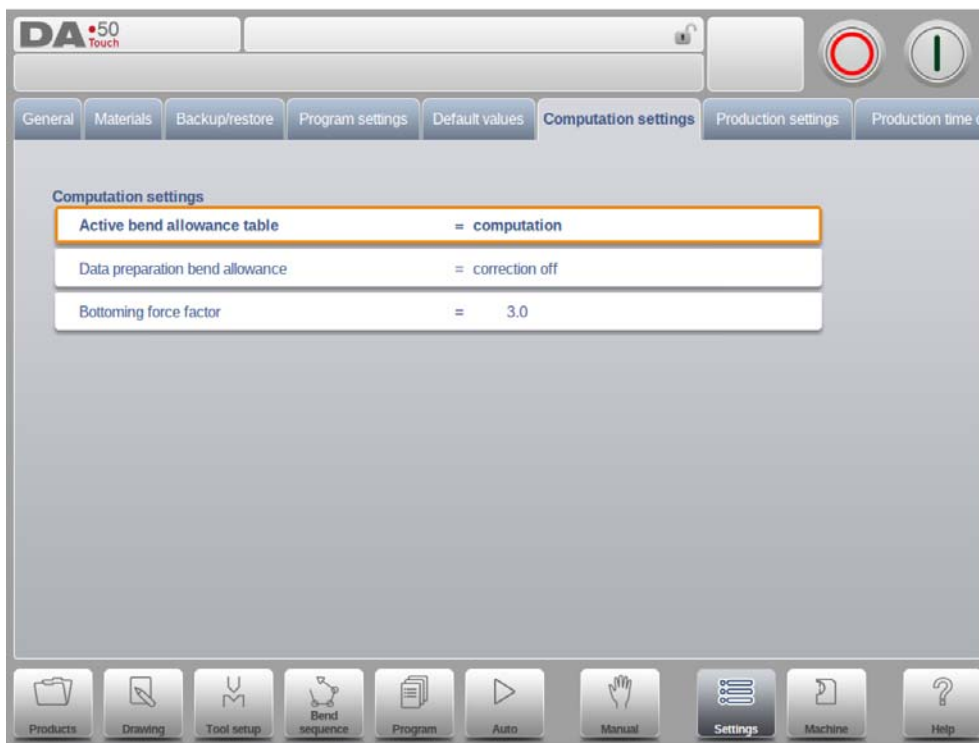

### Active bend allowance table

computation => the control will calculate the bend allowance  
table => the bend allowance table will be used

Bend-allowance is the correction of the X-axis due to sheet shortening after bending. With this parameter the method for bend-allowance calculation is chosen. 'Computation' means the standard formula of the control is used to calculate the bend-allowance. 'Table' means a bend-allowance table with correction values can be used. The choice 'table' is only available if a bend-allowance table is present on the control.

### Data preparation bend allowance

correction off => no bend-allowance added to numerical programming  
correction on => bend-allowance correction added to numerical programming  
With this parameter you can choose whether or not you wish to have programmed values corrected for bend-allowance. This setting only refers to corrections during product programming in the Program mode. If a numeric program has been entered with Corrections On, the axis corrections are calculated and stored in the program. These corrections can be viewed and edited in production mode (see 'Auto mode').

This choice has no effect on the post process function in the Drawing mode. When the control post processes to calculate a CNC program from a drawing with bend sequence, the control will always take bend-allowance into account.

When a bend-allowance table is present and the cursor is on the parameter Active Bend Allowance Table then an extra function is available: Edit Table. With Edit Table the table can be modified to meet user requirements. The table appears in a new window, with its own controls.

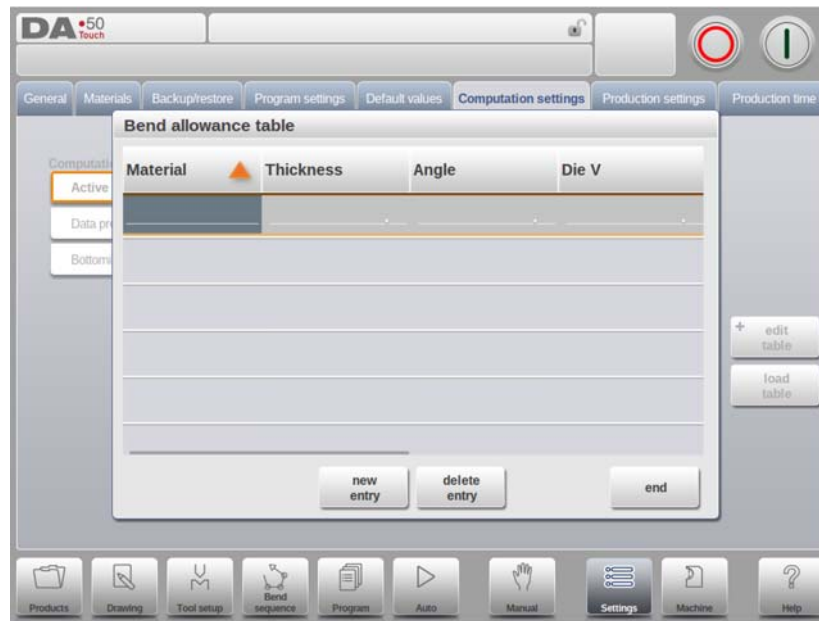

Each line contains a table entry, with several parameters. In this screen, the following functions are available:

Tab to select the field you wish to change. Then type the new value and press ENTER. It is not possible to create a table through this menu. Only when a table has been loaded into the control is it possible to edit its contents.

For more information about bend-allowance tables, we refer to the Delem manual of the bend-allowance table.

It is also possible to load an existing bend allowance table.

Tab Load Table to navigate to the desired file location.

### Bottoming force factor

The force needed for an air bend multiplied by this factor in order to obtain the bottoming force.

### Z-distance

The distance from the edge of the finger to the corner of the sheet.

When an automatic Z-axis has been installed, the position of the fingers is automatically calculated with respect to the end of the sheet.

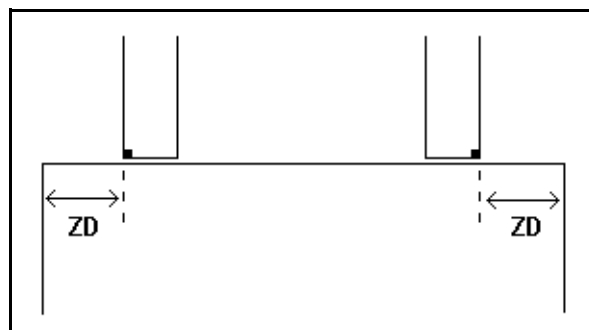

---

## 9.8. Production settings

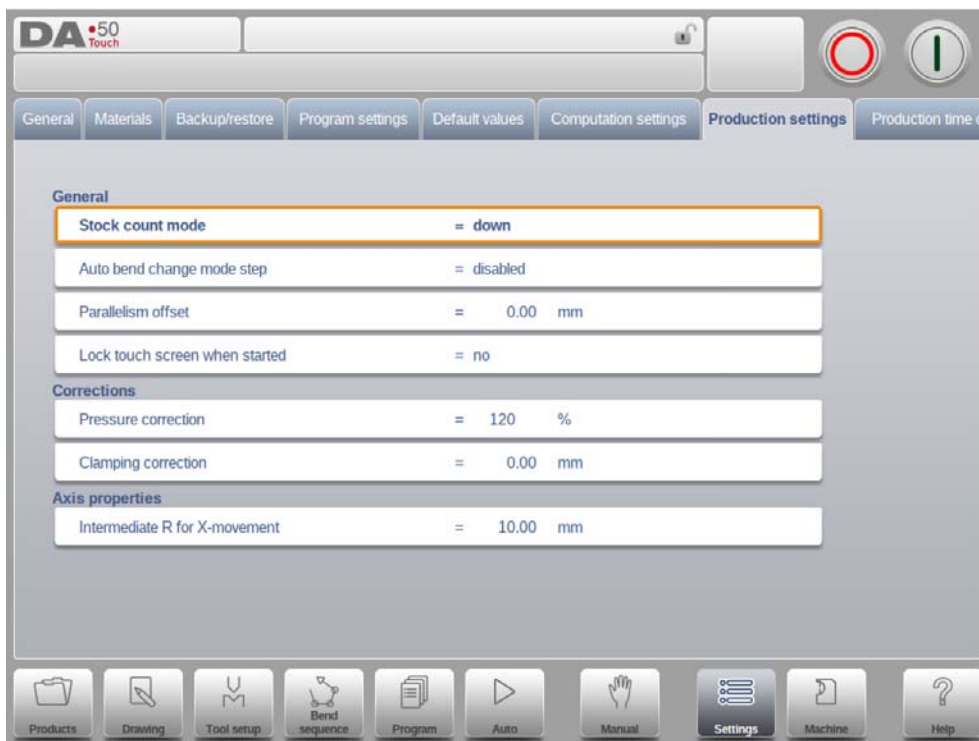

### Stock count mode

Setting for the stock counter in production mode, to have the stock counter (product counter) count up or down.

When down counting is selected, the stock counter in production mode is decremented after each product cycle. When the counter has reached zero, the control is stopped. On the next start action, the stock counting value is reset to its original value.

When up counting is selected, the counter is incremented after each product cycle.

Down counting can be useful if a pre-planned quota must be produced. Up counting could be used to give a report on production progress.

### Auto bend change mode step

This parameter can be used to have automatic step change in the bending process with the Step mode enabled.

disabled => No automatic step change (next bending parameters active) will take place. To perform the next bending you must select the new bending and press the start button.

enabled => The next bending parameters are loaded automatically but the axes will start positioning after the start button has been pressed..

### Parallelism offset

An overall parallelism, valid for the complete Y-axis stroke, can be programmed with this parameter. The programmed value will be checked against the maximum allowed value during production. The parallelism which can be programmed for each bending (Y2) is only active below the clamping point. The parallelism below the clamping point is the sum of the two parameters (Y2 + Parallelism offset).

## Lock touch screen when started

To enable the locking of the touchscreen while the controller is started.

## Pressure correction

Percentage of calculated force which actually controls the pressure valve.

## Clamping correction

The position of the beam at which the sheet is clamped, is calculated. In order to have a firm clamped sheet it is possible to offset the calculated pinch point with the value here programmed. A positive value will result in a deeper position, a negative value in a higher position of the beam.

## Intermediate X for Z-movement

Temporary safe value for the X-axis, to avoid collision as a result of movement along the Z-axis. With this parameter a standard safety zone for the X-axis is defined, which is valid for all programs. The value 0 disables this functionality. This parameter should not be confused with the parameter 'X-safety' of each die.

This parameter is especially useful when several dies of different sizes are placed on the machine. In that situation, this intermediate X-value should be larger than the safety zone of the largest die that is installed.

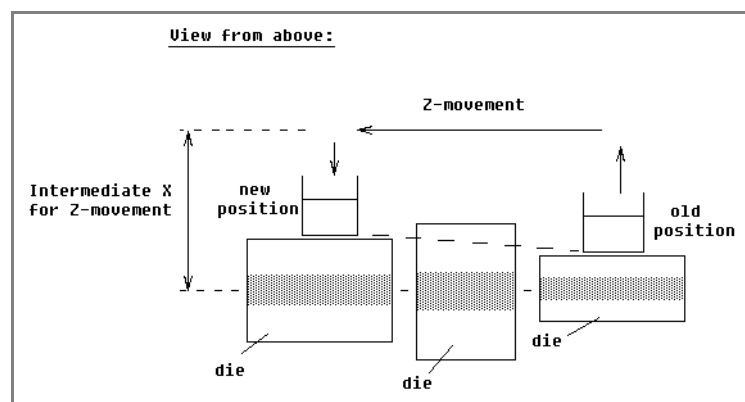

When the back gauge has to move to a different Z-position, it is checked whether the current X-position is safe. We can distinguish the following situations:

- Old X-axis position as well as new position outside the zone: X- and Z-axis movements happen at the same time, no change.
- Old X-axis position outside, new position inside the zone: back gauge is positioned on Z-axis first, the X-movement starts when the Z-axis is in position.
- Old X-axis position inside, new position outside the zone: back gauge starts along X-axis, Z-movement is started when X-axis is outside the zone.
- Old X-axis position as well as new position inside the zone: back gauge moves to the intermediate X-axis position, then the Z-movement is started. When the Z-axis is in position the X-movement is started to move the back gauge to its new position.

## Intermediate R for X-movement

Temporary position for the R-axis, to avoid collision as a result of movement of the X-axis. The value 0 disables this functionality. When programmed not equal to zero this position will be active when the X-axis has to move inside the safety zone of the die.

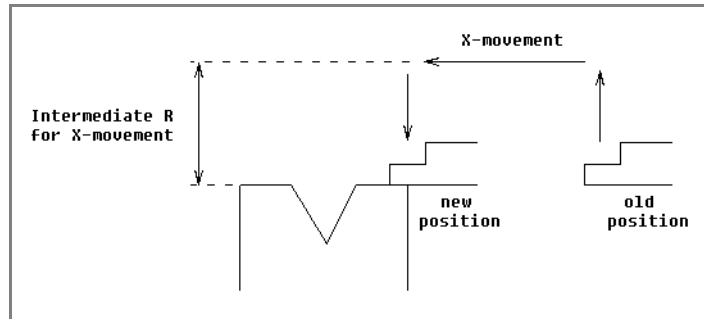

The sequence will be as follows:

- The R-axis is moved to the intermediate position;
- then the X-axis is moved to its intended position;
- finally the R-axis is moved to its intended position.

The safety zone of the die is defined as follows:

$$SZ = X\text{-safe} + SD$$

Explanation:

SZ = safety zone

X-safe = safety zone of the die

SD = safety distance, defined by machine supplier

## 9.9. Production time calculation

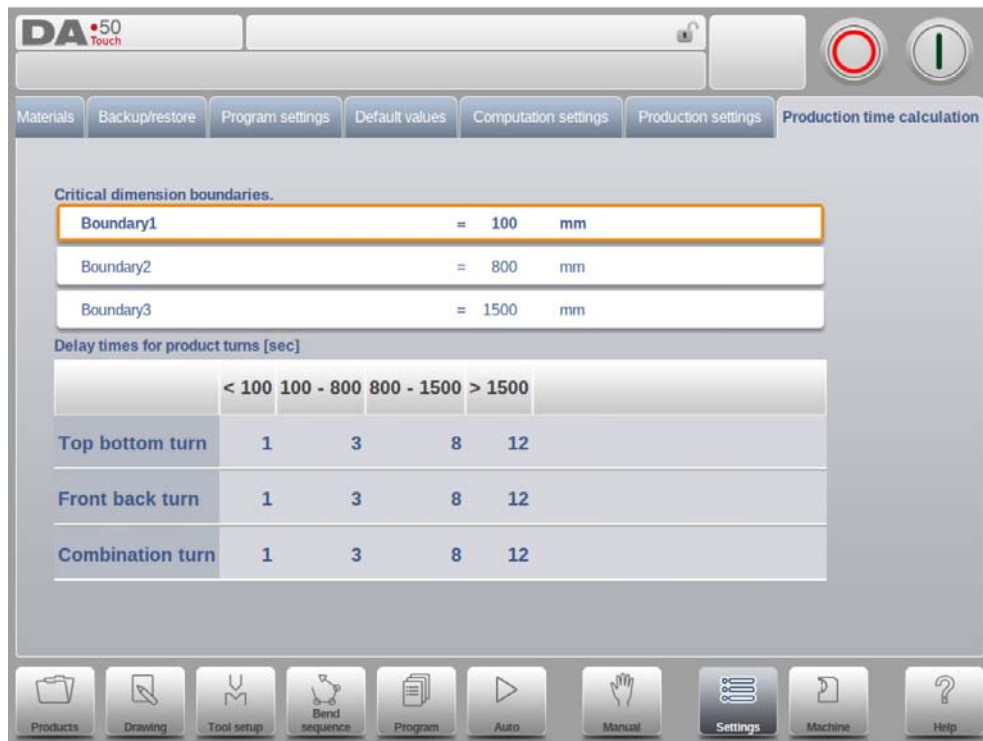

The parameters on this page are used to calculate the production time for a product in the bend sequence computation process. This production time depends on the positioning speed of the axes and the product handling times. The positioning speed is depending on machine settings.

Manual handling, turning of a product takes production time. This time depends upon the length and width of your product.

For a relative small product (in Z-direction) a top-bottom turn can be done quickly.

But a relative small product which is long (in X-direction) needs some longer time to turn from front to back or in a combination turn.

The turn time can be set in a table in seconds. For this purpose there are 4 length intervals (3 boundaries) each with a specific turn time depending on the type of turn. Like the turn times you also can set the length limit boundaries.

### Boundary 1/2/3

Threshold values for product size. For values between these boundary values different product turn times can be programmed.

---

## 9.10. Time settings

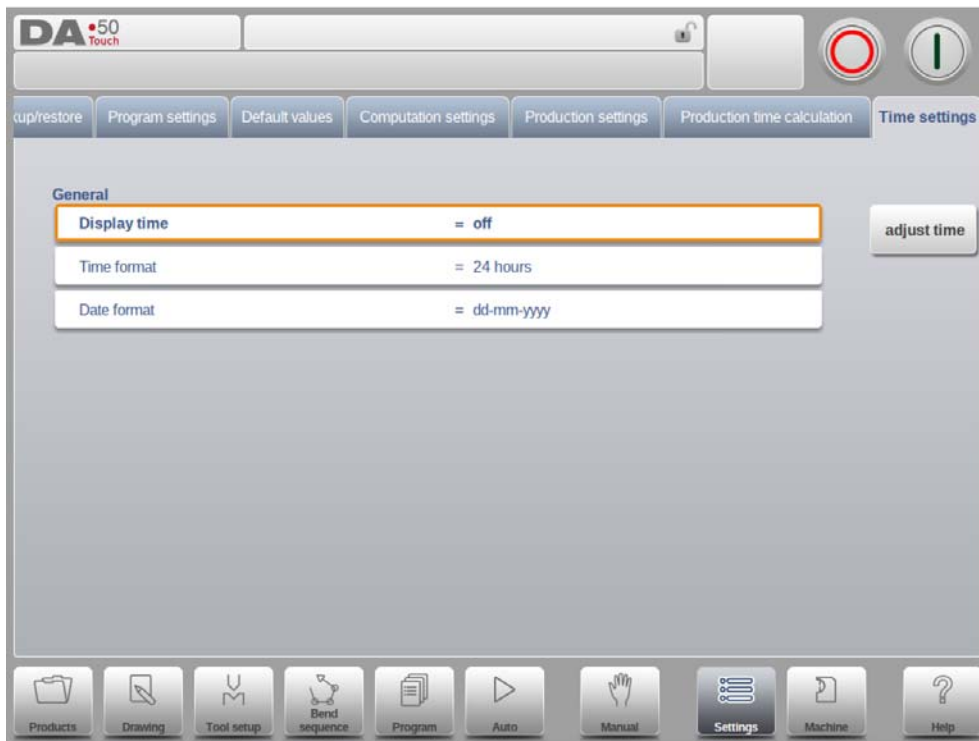

### Display time

Display date and time on the title panel, time only or no time at all.

### Time format

Display the time in 24 hours or 12 hours format.

### Date format

Display the date in dd-mm-yyyy, mm-dd-yyyy or yyyy-mm-dd format.

### Adjust time

To adjust the date and time. Adjusting the date and time will also adjust the date and time of the Windows operating system.

## **9.11. Network settings (only available when Network option has been installed)**

<to be described>

---

---

## 10. Machine

### 10.1. Introduction



By tapping the navigation button Machine the control is switched to Machine mode.

The Machine mode of the control, which can be found in the navigation panel, gives access to the configuration items of the machine and specific machine characteristics which influence generic calculations and machine behaviour.

The settings are divided across several tabs logically organizing the different subjects. In the following sections the available tabs and detailed settings are discussed.

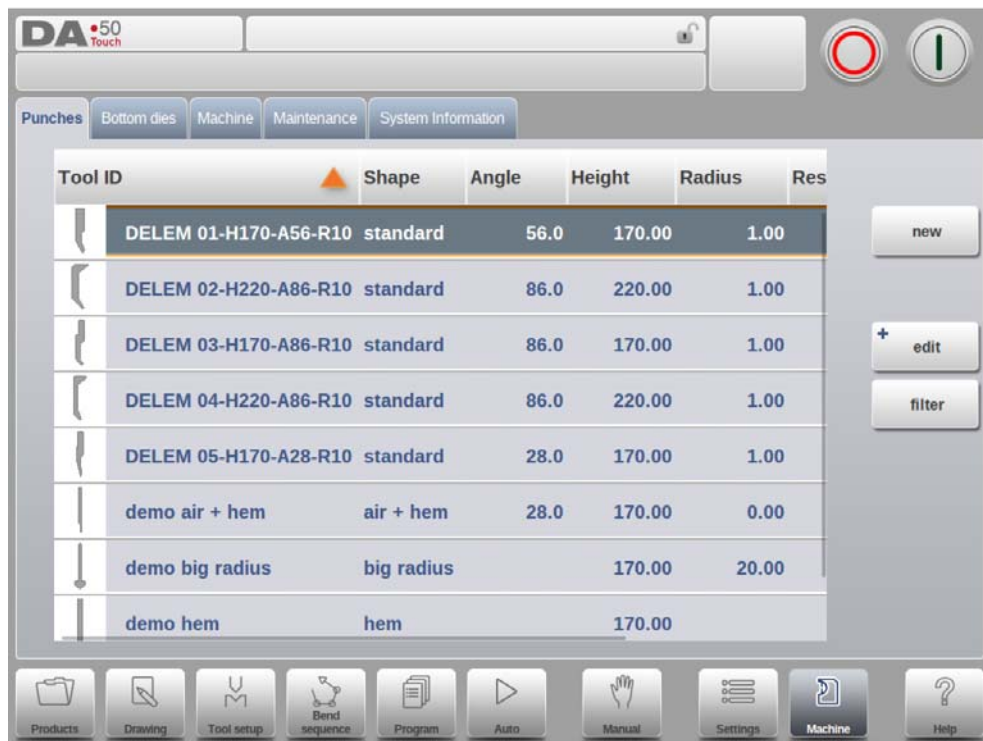

Navigation through the tabs can be done by just tapping them and selecting the required item to adjust. Since there can be more tabs than the screen can show in one view, dragging the tabs in horizontal direction enables to view and select all available tabs.

---

## 10.2. Programming of Punches

In this tab, the punches used in the machine, can be programmed. New punches can be added, existing punches can be edited and also deleted.

The screenshot displays the 'Punches' tab in the DA 50 Touch software. The interface features a top navigation bar with tabs for 'Punches', 'Bottom dies', 'Machine', 'Maintenance', and 'System Information'. Below the navigation bar is a table listing punch details. The table has columns for 'Tool ID', 'Shape', 'Angle', 'Height', 'Radius', and 'Res'. To the right of the table are buttons for 'new', '+ edit', and 'filter'. At the bottom of the interface is a toolbar with icons for 'Products', 'Drawing', 'Tool setup', 'Bend sequence', 'Program', 'Auto', 'Manual', 'Settings', 'Machine', and 'Help'.

Tool ID	Shape	Angle	Height	Radius	Res
DELEM 01-H170-A56-R10	standard	56.0	170.00	1.00	
DELEM 02-H220-A86-R10	standard	86.0	220.00	1.00	
DELEM 03-H170-A86-R10	standard	86.0	170.00	1.00	
DELEM 04-H220-A86-R10	standard	86.0	220.00	1.00	
DELEM 05-H170-A28-R10	standard	28.0	170.00	1.00	
demo air + hem	air + hem	28.0	170.00	0.00	
demo big radius	big radius		170.00	20.00	
demo hem	hem		170.00		

## 10.2.1. Create a new punch

To create a new punch, tap New in the library. The punch profile can be created with help of the programming and drawing facilities of the control.

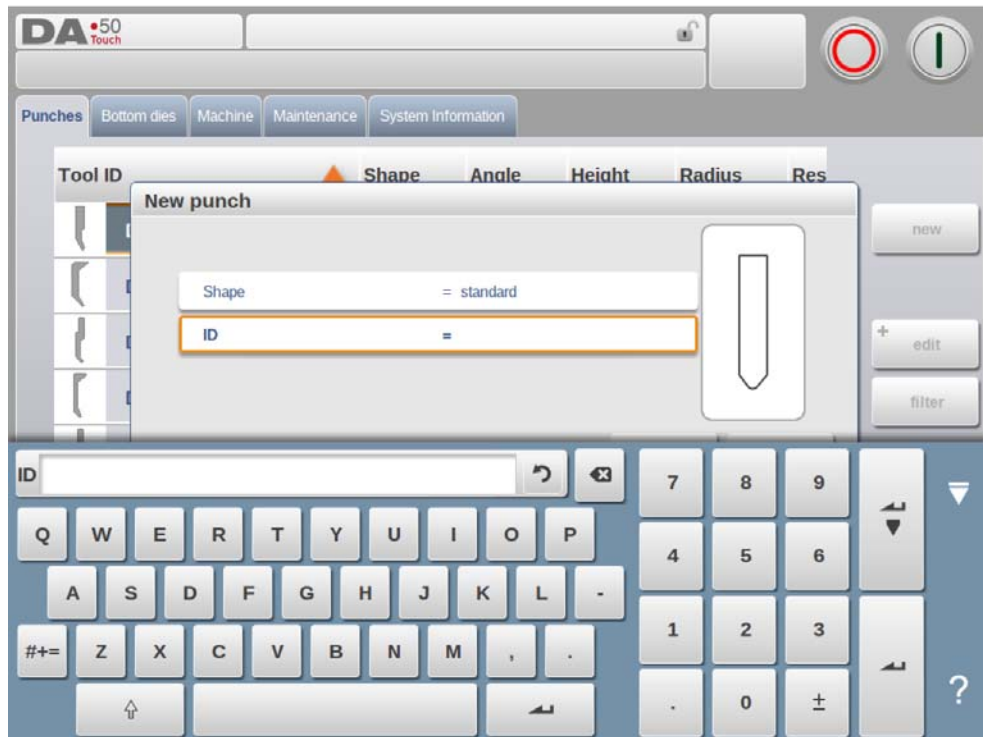

First the basic shape of the punch and its ID must be programmed. After that the shape details must be programmed following the wizard.

### Shape

A selection must be done from the different available basic punch shapes corresponding to the required punch action. Options are:

- Standard Punch shape as normally used for air bending and basic bottoming.
- Hem Bend Punch as typical tool with flat bottom for specific hem bends.
- Air + Hem Bend Punch as tool for normal air bends and hem function.
- Big Radius Punch shape especially for big radius bends.

### ID

A unique name or number to identify the tool. The maximum length is 25 characters.

The ID parameter may also contain alphanumeric characters. When finished, use Accept to leave this window and start with the tool data parameters. The control will start by prompting a pop-up window for the tool properties starting with the initial dimensions of the tool.

Depending on the chosen basic shape, the parameters will differ. In the following paragraphs the available punch shapes are described in detail.

---

## 10.2.2. Standard punch

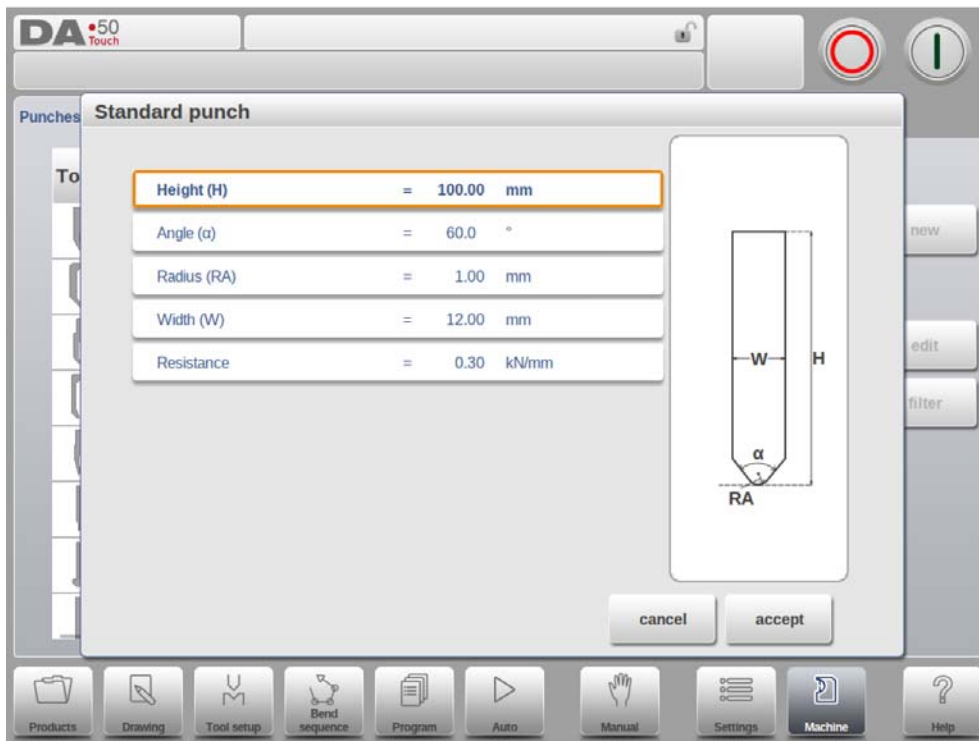

### Height

The height the tool. Important: this height value will be used in the bend depth calculation.

### Angle

The angle of the punch tip.

### Radius

The radius of the punch tip. This value will be used as inner radius of the bend to make when this radius value is bigger than the inner radius as will result from the bending process.

### Width

The width of the tool to program.

### Resistance

Maximum allowable force on the tool.

## Drawing orientation of the punch on the screen

The right hand side of the tool is the back gauge side. The bottom point of the punch will be placed on the center line of the press brake shape.

## Drawing

After entering these typical values you can create the tool drawing with the drawing facilities. Drawing a tool profile is done by entering angle values and line length values. Also the Touch drawing tools are available as with the product drawing method.

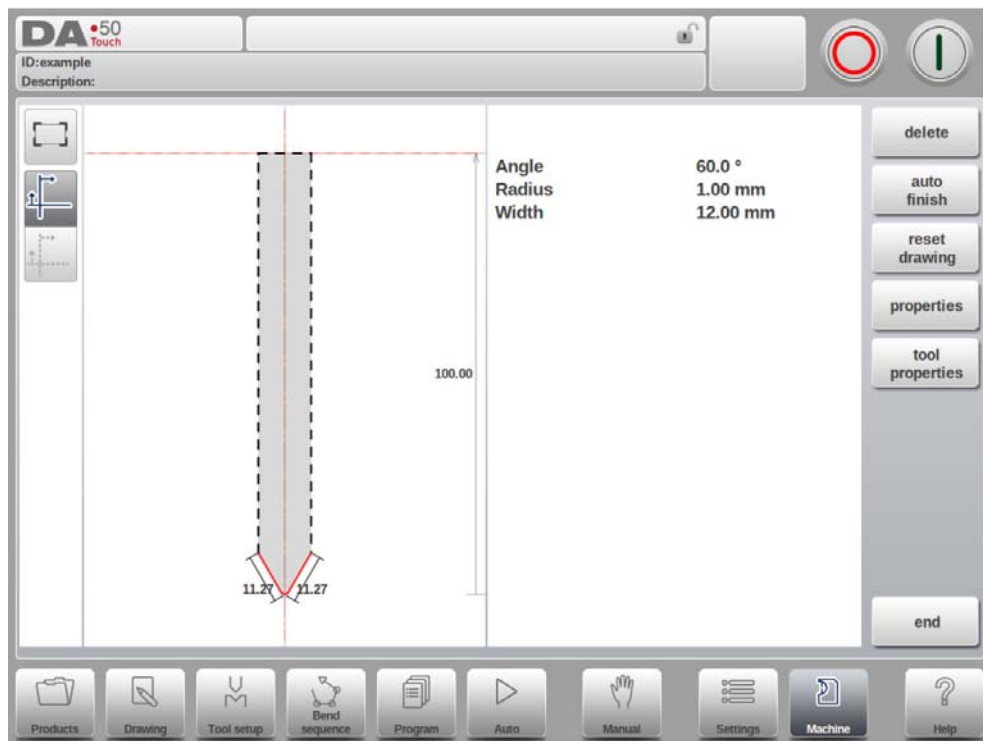

## Following functions are available while drawing

### Delete Line

To delete a line segment.

### Auto Finish

Finishing the tool outline to the top of the tool automatically.

### Reset Drawing

To reset the programmed drawing of the tool till the basic, initial shape, when creating a new punch.

### Reload Drawing

To reload the programmed drawing of the tool till the basic, initial shape, when changing an existing punch.

---

## Properties

To change the specific properties of the line or angle, add or remove a radius, change the length, etc. It is e.g. possible to add a radius in the outline of the tool.

## Tool Properties

To change the generic tool data and description.

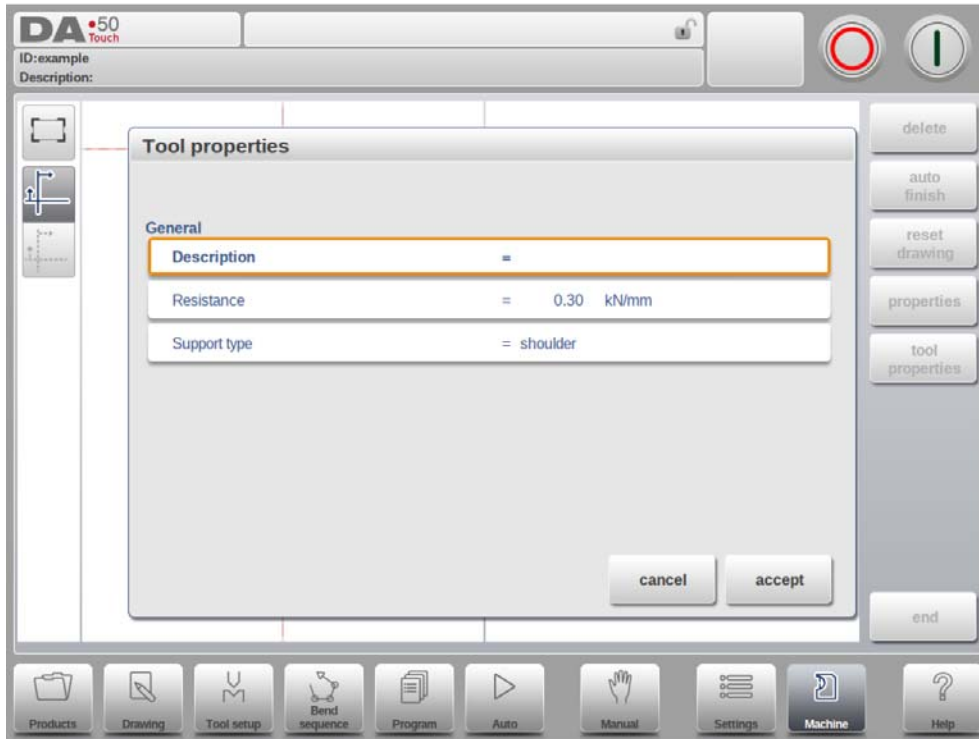

## Description

A name or description of this tool. The maximum length is 25 characters. This description has already been entered in the beginning defining the tool, but can be edited in this field. The description is listed in the tool overview of the library.

## Resistance

Maximum allowable force on the tool.

## Support type

Switch parameter, to account for differently mounted punches. Such punches could cause inaccuracies in the tool height and the resulting Y-axis position. The control makes a distinction between two settings, 'head mounted' and 'shoulder mounted'.

0 = shoulder mounted (default setting)

1 = head mounted

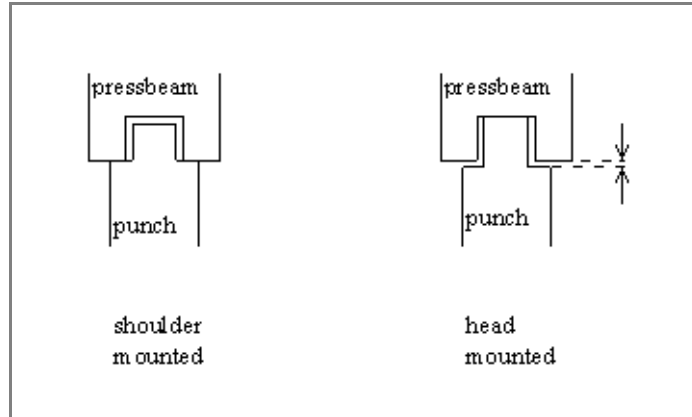

If 'shoulder mounted' is chosen, the Y-axis position is calculated from the standard tool height. This is the default setting.  
If 'head mounted' is chosen, a correction is made for Y-axis computation

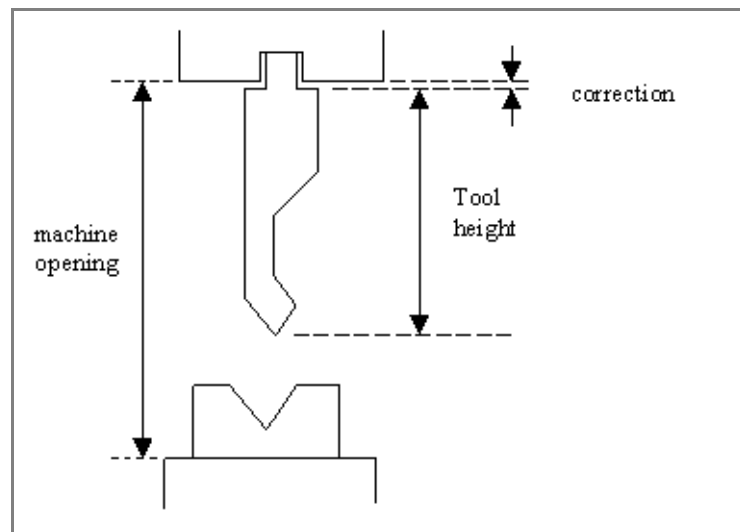

## Edit punch drawing

To edit an existing tool, tap the tool in the library. The tool appears on the screen and can be edited with the drawing facilities.

---

### 10.2.3. Hem bend punch

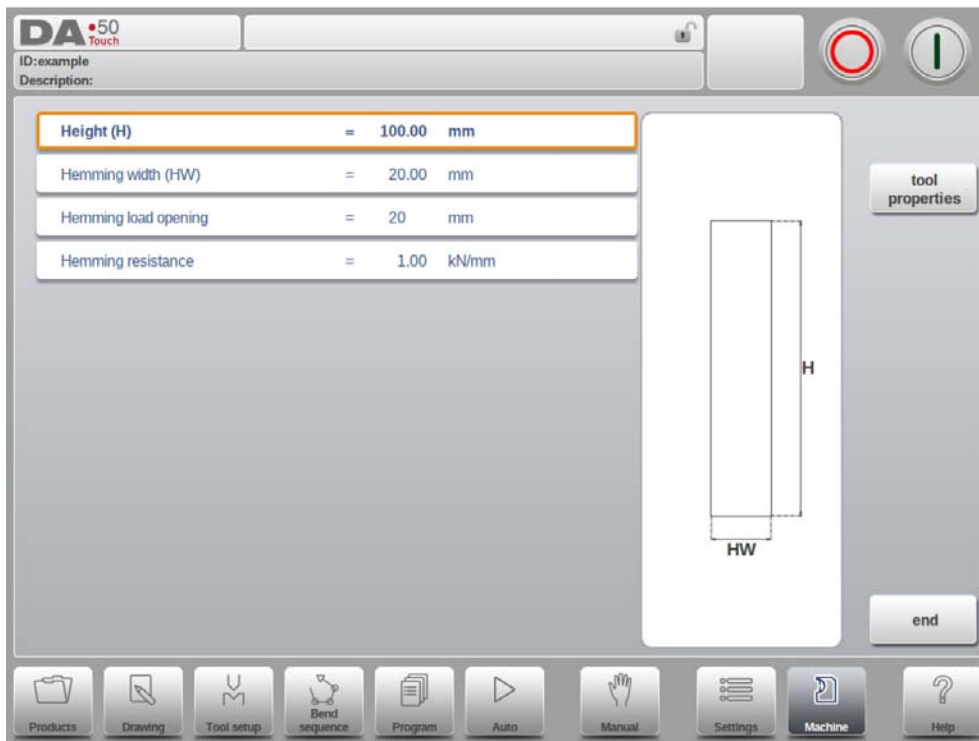

#### Height

The total height of the tool. Important: this height value will be used in the bend depth calculation.

#### Hemming width

The width of the tool to program.

#### Hemming load opening

Depending on the construction of your machine you can program here an opening position for your punch at which position you can put in your product to hem the particular bend. The opening position will also take twice the sheet thickness into account.

#### Hemming resistance

Maximum allowable force on the tool during hemming.

## 10.2.4. Air + hem bend punch

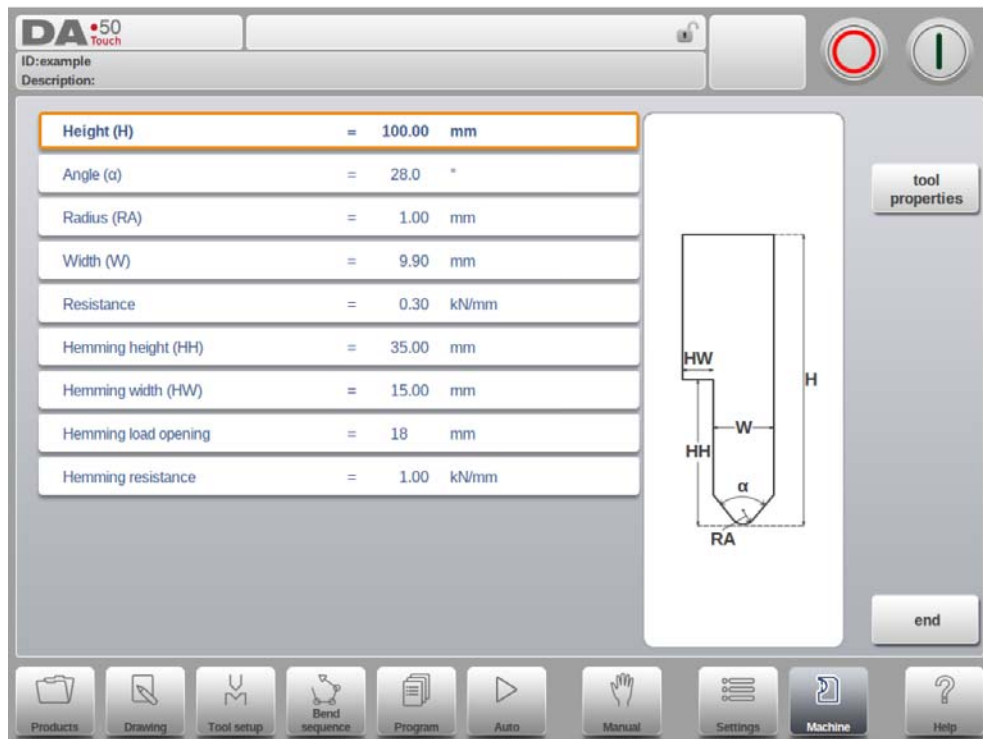

### Height

The total height of the tool. Important: this height value will be used in the bend depth calculation.

### Angle

The angle of the punch tip.

### Radius

The radius of the punch tip. This value will be used as inner radius of the bend to make when this radius value is bigger than the inner radius as will result from the bending process.

### Width

The width of the tool to program.

### Resistance

Maximum allowable force on the tool.

### Hemming height

The height of the punch used to move down in case of the hemming function.

### Hemming width

The width of the punch part used to lay in the product for the hemming action.

### Hemming load opening

Depending on the construction of your machine you can program here an opening

---

position for your punch at which position you can put in your product to hem the particular bend. The opening position will also take twice the sheet thickness into account.

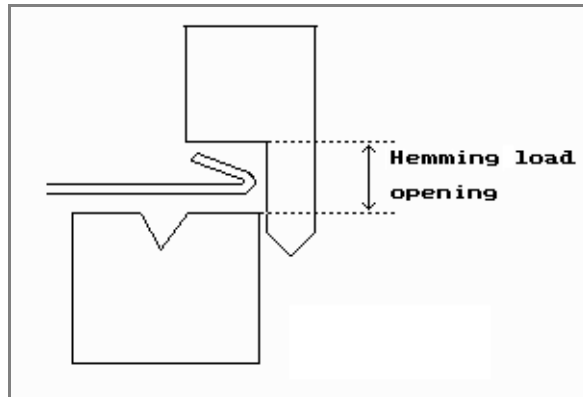

**Hemming resistance**

Maximum allowable force on the tool during hemming.

## 10.2.5. Big radius punch

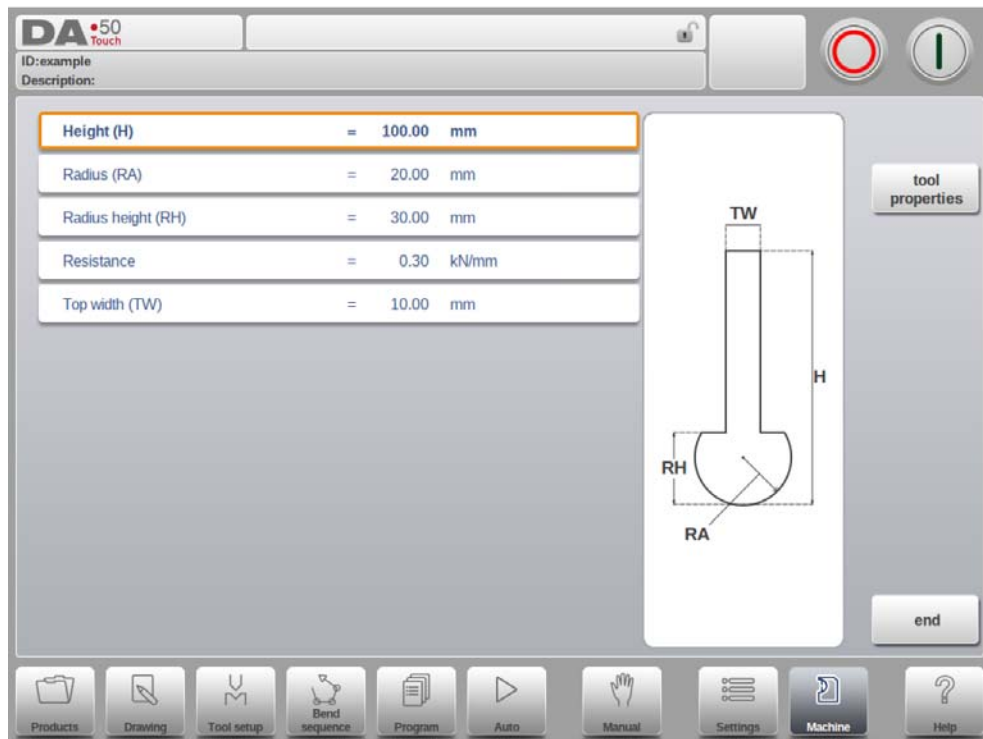

### Height

The total height of the tool. Important: this height value will be used in the bend depth calculation.

### Radius

The radius of the punch tip.

### Radius height

The height of the big radius part of the special tool as indicated in the drawing on the screen for the basic data.

### Resistance

Maximum allowable force on the tool.

### Top width

The width of the tool on the top side of the punch.

---

### 10.3. Programming of bottom dies

In this tab, the bottom dies used in the machine, can be programmed. New dies can be added, existing dies can be edited and also deleted.

Tool ID	Shape	V	Angle	Height	Radius
DELEM 01-H120-A30-V062	standard	6.20	30.0	120.00	
DELEM 02-H120-A30-V084	standard	8.40	30.0	120.00	
DELEM 03-H120-A30-V104	standard	10.40	30.0	120.00	
DELEM 04-H120-A30-V124	standard	12.40	30.0	120.00	
DELEM 05-H120-A30-V166	standard	16.60	30.0	120.00	
demo air + hem U	air + hem U	10.00		120.00	
demo hem	hem			120.00	
demo inside hem	inside hem	10.00	30.0	120.00	

## 10.3.1. Create a new die

To create a new tool, tap News in the die library. The control will start by asking for the required tool shape and tool identification name (ID).

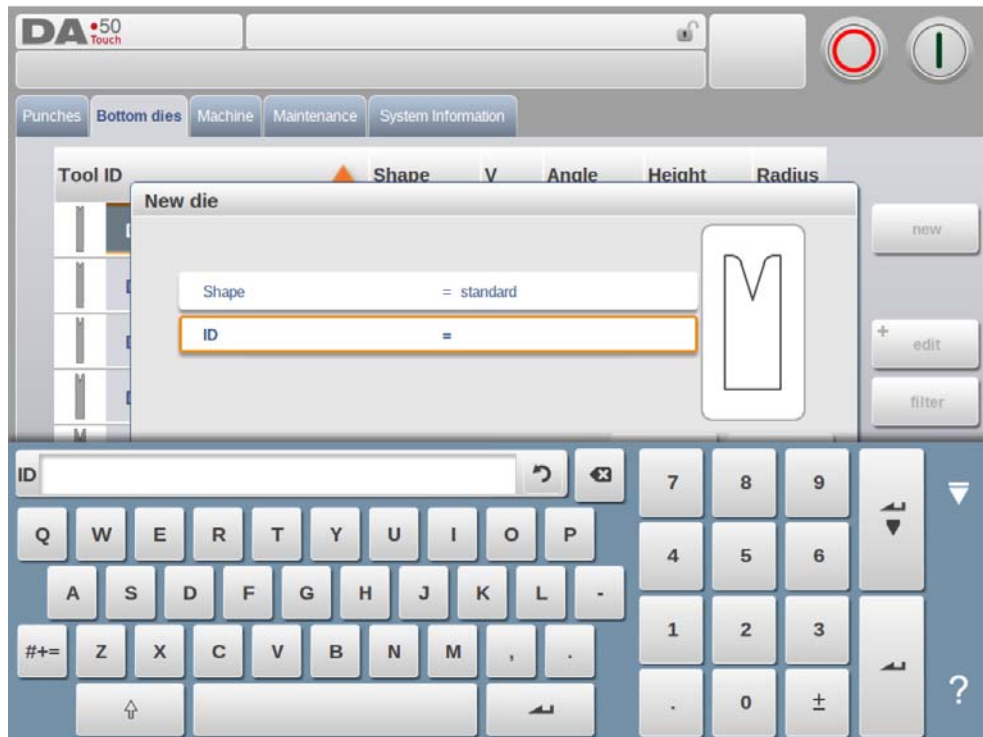

### Shape

A selection must be done from the different available basic die shapes corresponding to the required die action. Options are:

- Standard Die shape as normally used for air bending and basic bottoming.
- Hem Bend Die as typical tool with flat top for specific hem bends.
- Inside Hem Bend Die as tool for air bends and hem function.
- Air + Hem Bend U Die shape for air bends and specific hem function.

### ID

A unique name or number to identify the tool. The maximum length is 25 characters.

The ID and description parameters may also contain alphanumeric characters. When finished, Accept to leave this window and start with the tool data parameters. The control will start by prompting a pop-up window for the tool properties starting with the initial dimensions of the tool.

### 10.3.2. Standard die

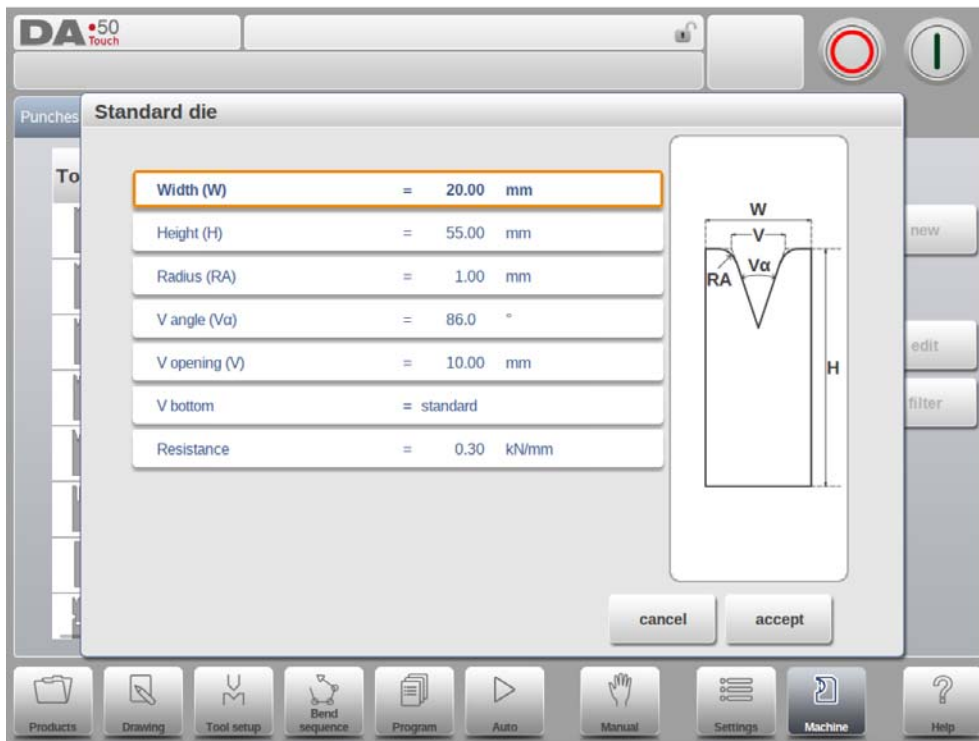

#### Width

The width of the tool to program.

#### Height

The total height of the tool. Important: this height value will be used in the bend depth calculation.

#### Radius

The radius of the edges of the V-opening.

#### V angle

The angle of the die.

#### V opening

The V-opening of the die.

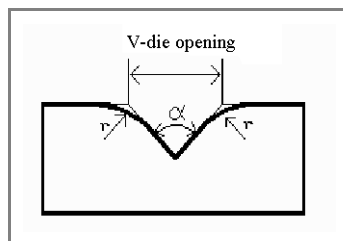

The width V is the distance between the touching lines crossing.

## V bottom

Herewith the different possible bottoms inside the V opening can be defined:

- Standard is a sharp angle in the bottom of the die.
- Round is a die bottom with a radius to be programmed with the parameter 'Inside radius'.
- Flat is a flat die bottom with a certain dimension to be set with the parameter 'Bottom width'.

## Resistance

Maximum allowable force on the tool.

## Drawing orientation of the die on the screen

The right hand side of the tool is the back gauge side. The mid-position of the V-opening will be placed on the centre line of the press brake shape.

## Drawing

After entering these typical values you can create the tool drawing with the drawing facilities. Drawing a tool profile is done by entering angle values and line length values. Also the Touch drawing tools are available as with the product drawing method.

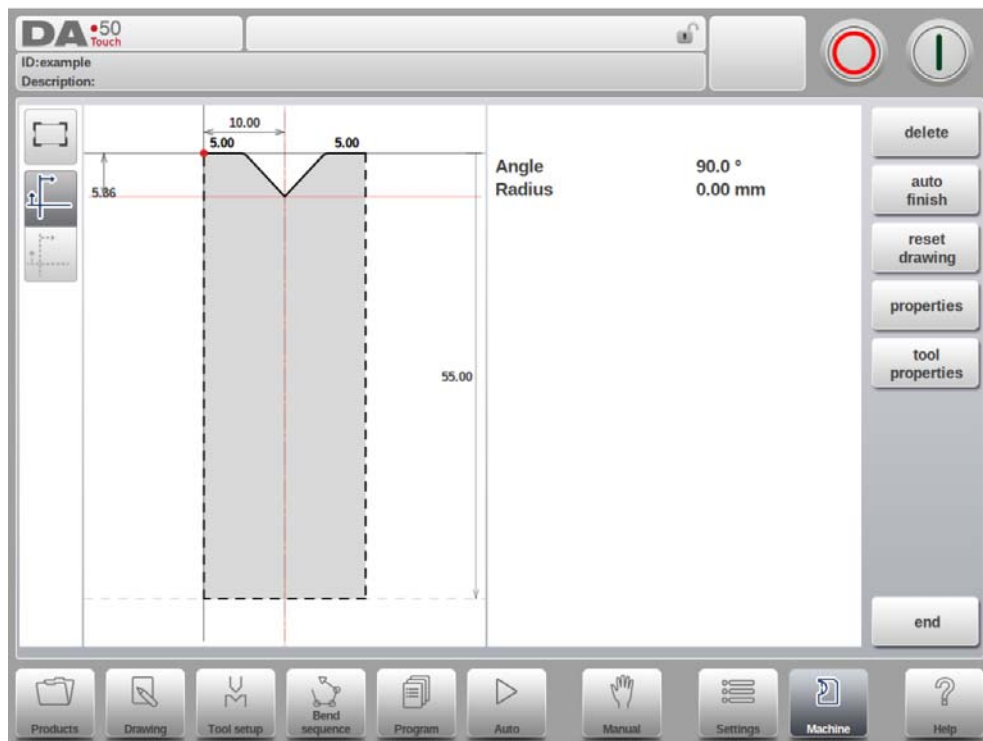

## Following functions are available while drawing

### Delete Line

To delete a line segment.

### Change Height

---

To change the height dimension of the tool.

### Auto Finish

Finishing the tool outline to the top of the tool automatically.

### Reset Drawing

To reset the programmed drawing of the tool till the basic, initial shape, when creating a new die.

### Reload Drawing

To reload the programmed drawing of the tool till the basic, initial shape, when changing an existing die.

### Properties

To change the specific properties of the line or angle, add or remove a radius, change the length, etc. It is e.g. possible to add a radius in the outline of the tool.

### Tool Properties

To change the generic tool data and description.

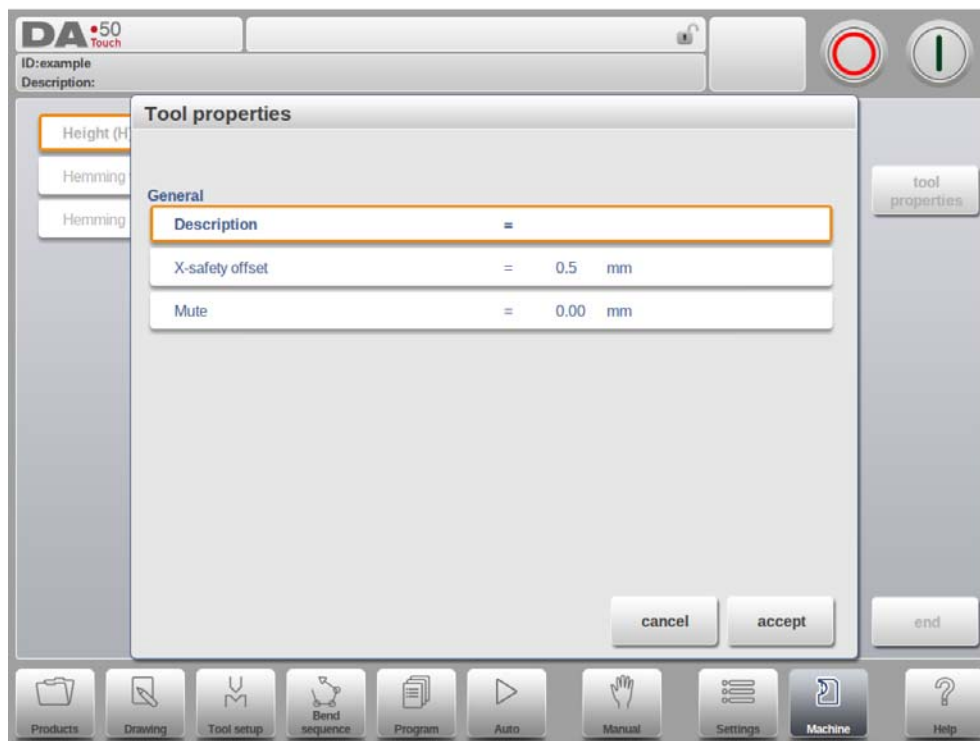

### Description

A name or description of this tool. The maximum length is 25 characters. This description has already been entered in the beginning defining the tool, but can be edited in this field. The description is listed in the tool overview of the library.

### Resistance

Maximum allowable force on the tool.

**X-safety offset**

Calculated safety zone (minimum X-axis value), following the contour of the tool shape, which will be used in the case a R-axis is mounted. This to prevent finger to die collision.

**Mute**

Muting distance. Distance above the sheet at which the speed change takes place.

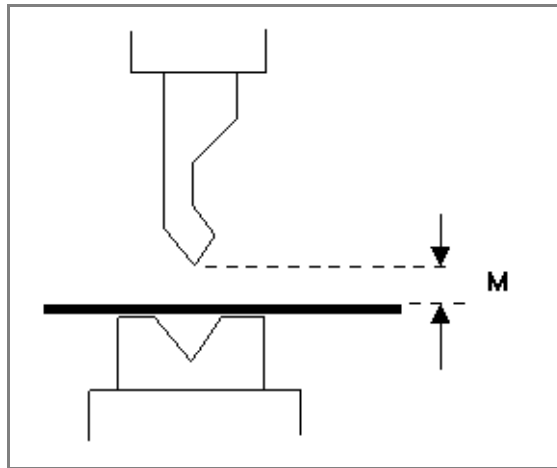
**Edit die drawing**

To edit an existing tool, tap the tool in the library. The tool appears on the screen and can be edited with the drawing facilities.

---

### 10.3.3. Hem bend die

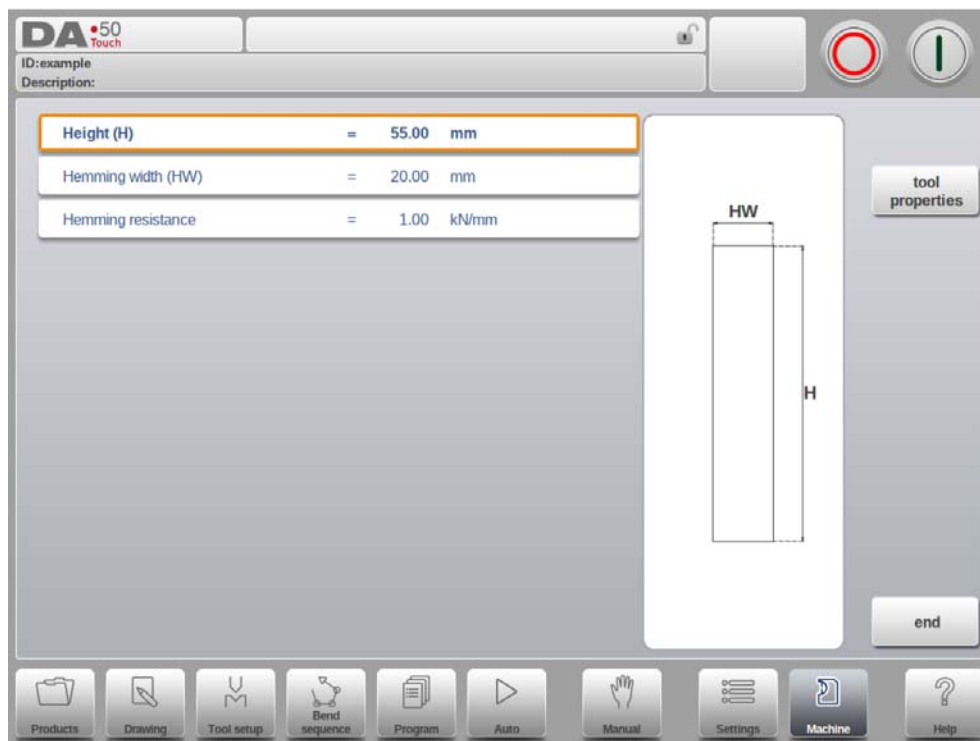

#### Height

The total height of the tool. Important: this height value will be used in the bend depth calculation.

#### Hemming width

The width of the tool to program.

#### Hemming resistance

Maximum allowable force on the tool during hemming.

## 10.3.4. Inside hem bend die

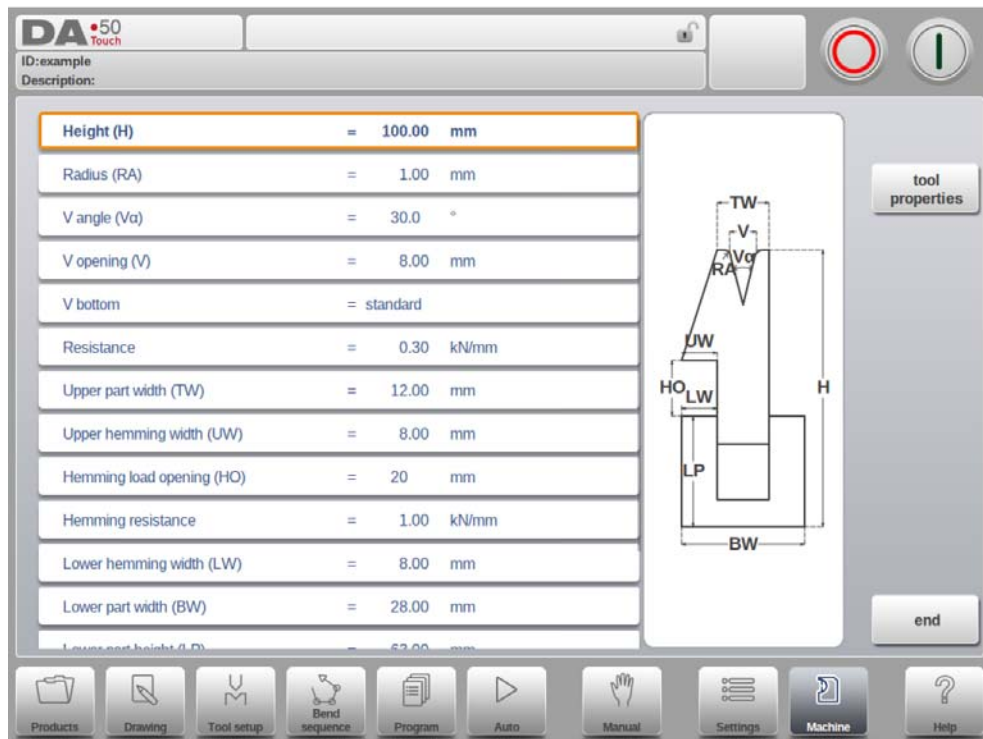

### Height

The total height of the tool. Important: this height value will be used in the bend depth calculation.

### Radius

The radius of the edges of the V-opening.

### V angle

The angle of the die.

### V opening

The V-opening of the die.

### V bottom

Herewith the different possible bottoms inside the V opening can be defined:

- 'Standard' is a sharp angle in the bottom of the die.
- 'Round' is a die bottom with a radius to be programmed with the parameter 'Inside radius'.
- 'Flat' is a flat die bottom with a certain dimension to be set with the parameter 'Bottom width'.

### Resistance

Maximum allowable force on the tool.

### Upper part width

The width of the upper part of the die.

---

**Upper hemming width**

The width of the segment in the upper part of the die used for the hemming action.

**Hemming load opening**

The opening height of the die in the opened status to place the product with the hem bend.

**Hemming resistance**

Maximum allowable force on the tool during hemming.

**Lower hemming width**

The width of the segment in the lower part of the die used for the hemming action.

**Lower part width**

The width of the lower part of the die.

**Lower part height**

The height of the lower part of the die.

**Inside hemming die type**

For the different types of available inside hemming dies the specific operation mode can be selected:

- Spring Opened    This die has an internal spring to push the die upwards as start position.  
Pre-Bend: For the pre-bend the sheet will be placed on top of the die in this opened position and the final bend position is calculated such that the required pre-bend angle will be reached. The backgauge height (R-axis) will be calculated on the level of the opened die so that the product can be placed against the backstop.  
Hem-Bend: For the hemming operation the pre-bent product will be placed in the hem opening of the die and the depth calculation of the pressing beam will be such that the die is pressed down until the hem bend is finished. The calculation will take twice the sheet thickness into account. It is possible to program an additional hem opening parameter in the specific bend parameters as offset on the final hem position.
- Open & Locked    This die is standard locked in a high position for normal bending and pre-bend angles. The lock mechanism must be removed to use the hemming facility.
- Normally Closed    This die is in a closed, low position for normal bending and pre-bend angles, and should be activated to get the hemming action.

**Adjust decompression**

To enable the addition of the hemming load opening value to the decompression distance of a normal air bend cycle. This parameter is only available for spring-opened hemming dies. Default: off.

## 10.3.5. Air + hem bend U die

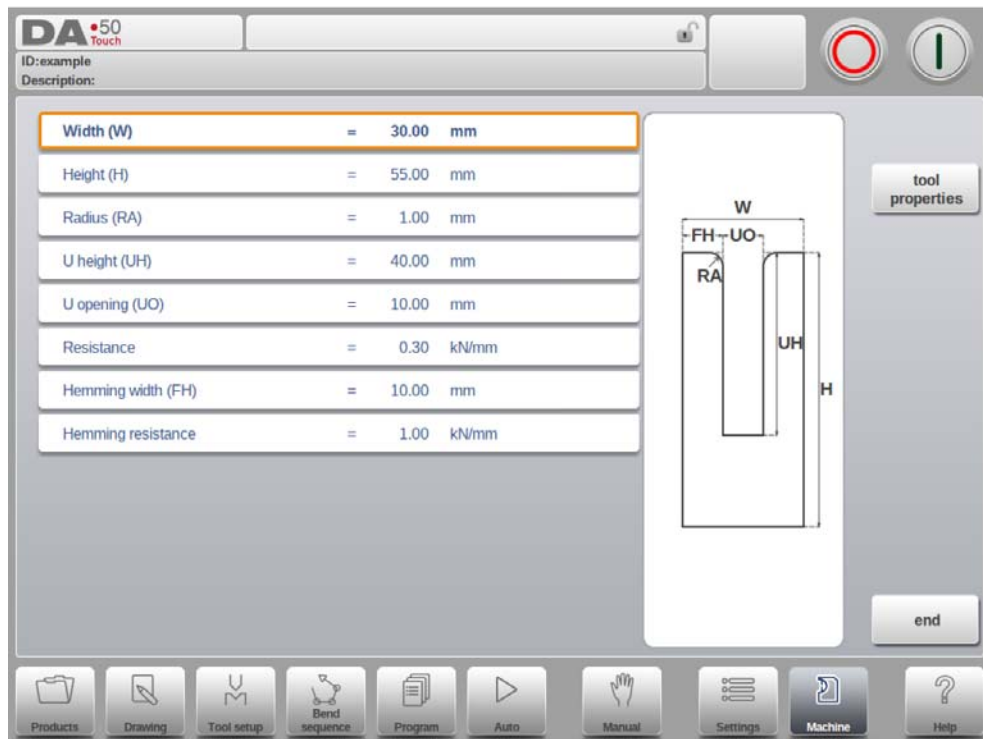

### Width

The width of the tool to program.

### Height

The total height of the tool. Important: this height value will be used in the bend depth calculation.

### Radius

The radius of the edges of the U-opening.

### U height

The height of the U-opening of the die.

### U opening

The width of the U-opening of the die.

### Resistance

Maximum allowable force on the tool.

### Hemming width

The front width of the die, meant as support for the hem bend.

### Hemming resistance

Maximum allowable force on the tool during hemming.

---

## 10.4. Machine

With the backgauge finger dimensions the R-axis movement and related X-axes movement is taken into account. Also the workpiece / backgauge collision are computed using the dimensions.

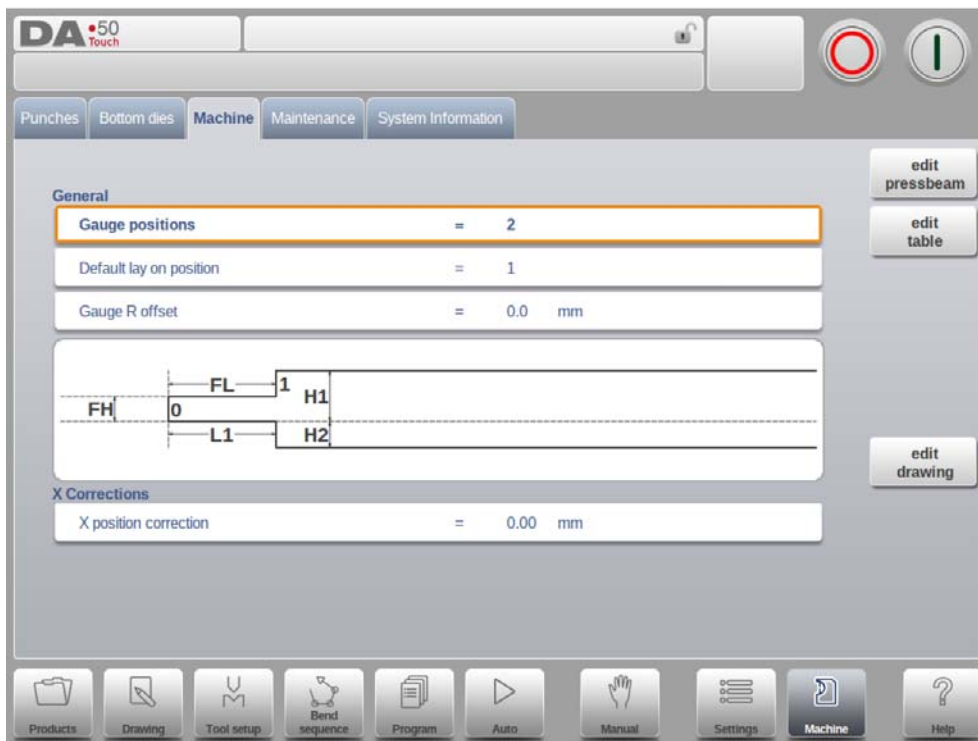

### Gauge positions

The number of possible gauge positions (max. 4). When this parameter is changed, a new pop-up window with finger geometry appears. There the finger dimensions can be programmed.

### Default lay on position

This is the default lay-on position in case a lay-on position must be used during automatic bend sequence computation, e.g. in case the X-axis position is outside its allowed range or larger than the 'Lay-on backstop limit'; it is not used when selecting a lay-on level manually.

Meaning of lay-on numbers:

Lay-on = 1

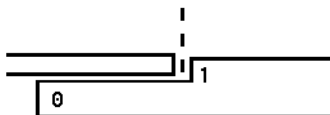

### Gauge R offset

An offset value for the R-axis can be set if the backgauge is positioned against the sheet

edge and the X-axis position is outside the die safety zone.

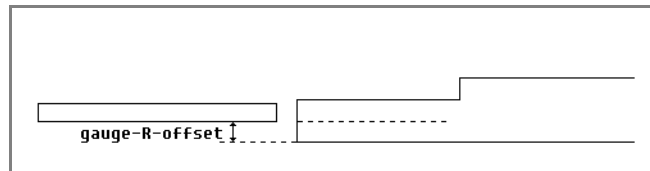

A negative value gives a lower backgauge position. This offset is only valid for gauge position 0.

## Finger width

The width of the backgauge finger. Only available when an automatic Z-axis has been installed.

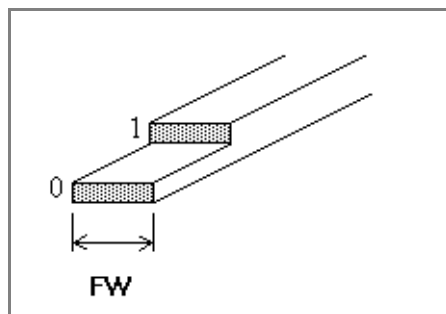

## X position correction

When the actual, mechanical axis position is not corresponding with the displayed value than is it possible to correct the position with this parameter. Program the calculated difference.

Example:

- When the programmed and displayed value = 250 and the actual, mechanical position value = 252 the CX parameter = -2.
- When the programmed and displayed value = 250 and the actual, mechanical position value = 248 the CX parameter = +2.

In case there are several X-axes installed, a separate parameter is available for each X-axis.

Tap Edit Pressbeam to draw the details of the pressbeam, similar to drawing of tools. Either by tapping and sketching or by giving in the length of sides and pointing the direction of the next side.

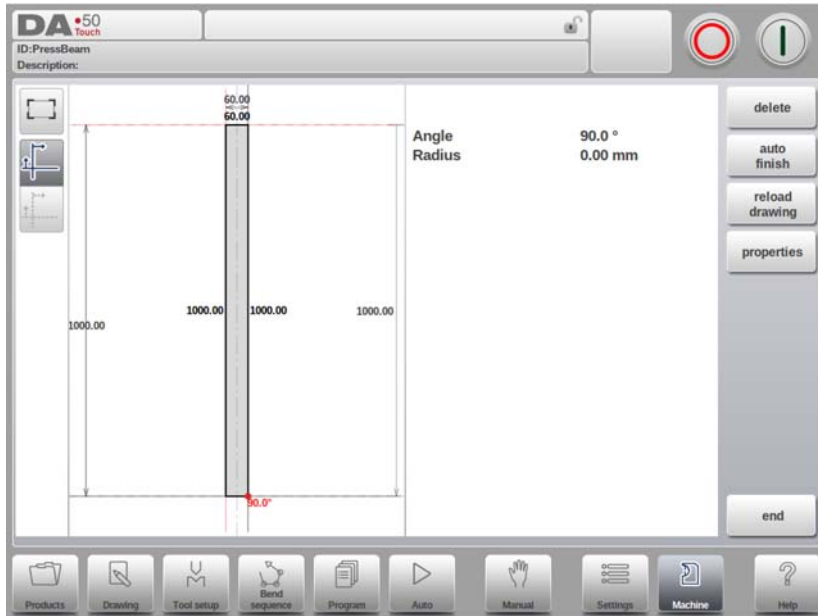

Tap Edit Table to draw the details of the table, similar to drawing of tools. Either by tapping and sketching or by giving in the length of sides and pointing the direction of the next side.

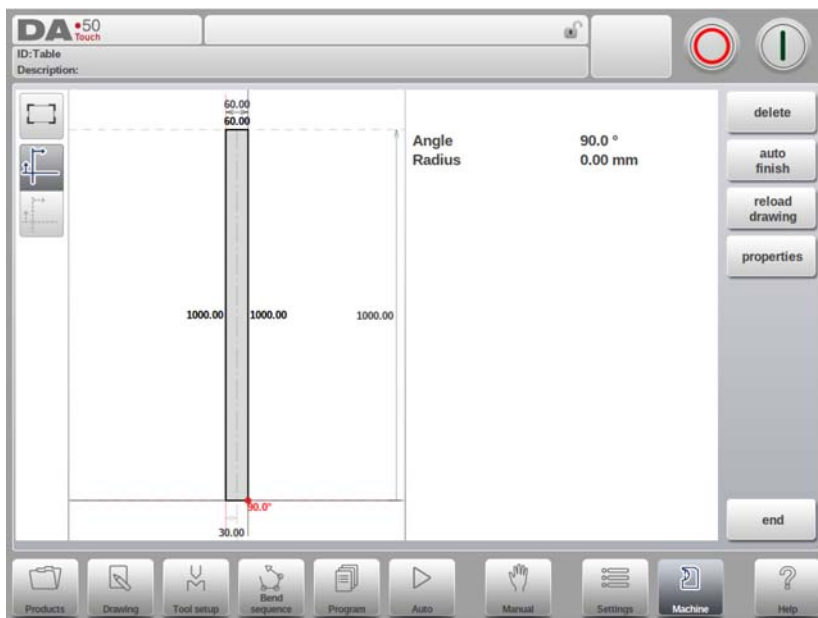

Tap Edit Drawing to make the background drawing appear wherein the dimensions of the background finger can be programmed.

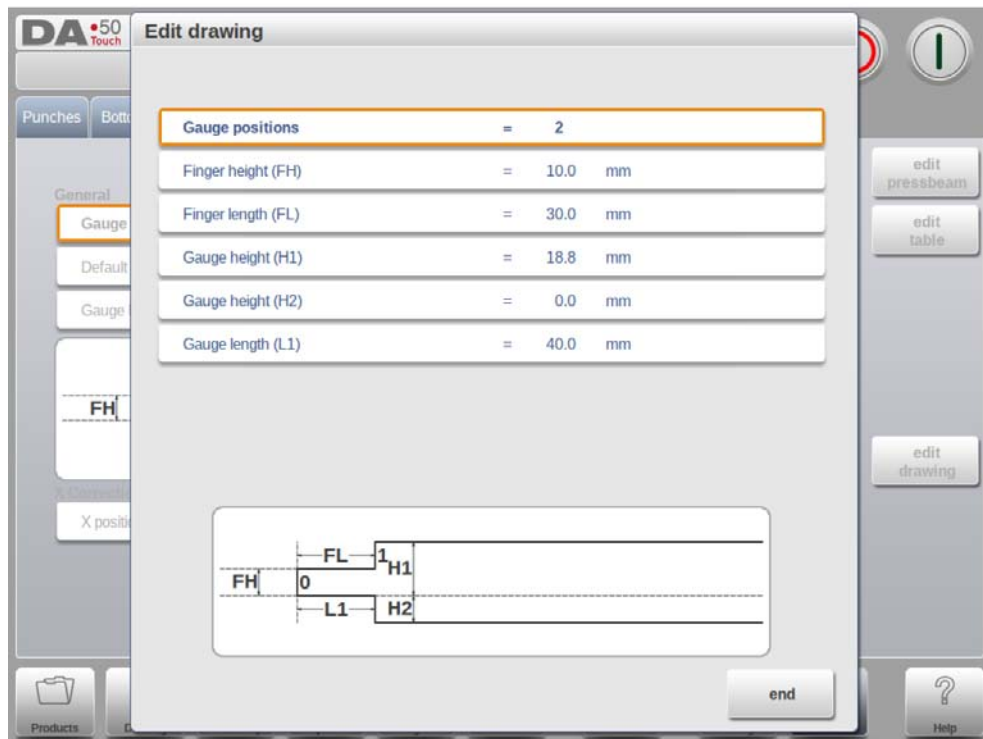

The following parameters describe the dimensions of the backgauge and the lay-on positions. The number of parameters that has to be programmed depends on the number of gauge positions. If more gauge positions are programmed, more parameters are offered. The illustration at the bottom of the screen will change according to the number of gauge positions.

### **Finger height (FH)**

The height (or thickness) of the first backgauge finger tip.

### **Finger length (FL)**

The length of the first finger level.

### **Gauge height (H1/H3/H4)**

The height of the different finger levels.

### **Gauge length (L2/L3)**

The length of additional lay-on levels.

### **Gauge height (H2)**

The height of the bottom of the gauge.

### **Gauge length (L1)**

The length of the finger level at the bottom of the gauge.

---

## 10.5. Drawing functionality for tools and machine shapes

In programming punches, dies and also machine shapes, after the main data the control provides the functionality to freely draw the desired shape in the object. This functionality makes the objects appear more realistic but most of all enables the control to do an accurate collision prevention.

In this drawing functionality multiple methods can be used to have the desired shape. One can sketch the desired shape and after that change segments to program their accurate value. One can also start doing this from the first drawn segment, step by step.

Important to know is the following:

- In the end these shapes should be closed. The auto-finish function can help with that.
- The height of the programmed object is used in the bending calculations. Keep in mind that this is very important to get to the desired results.

Helpful to know can be the following:

- A line as well as an angle can be given a radius.

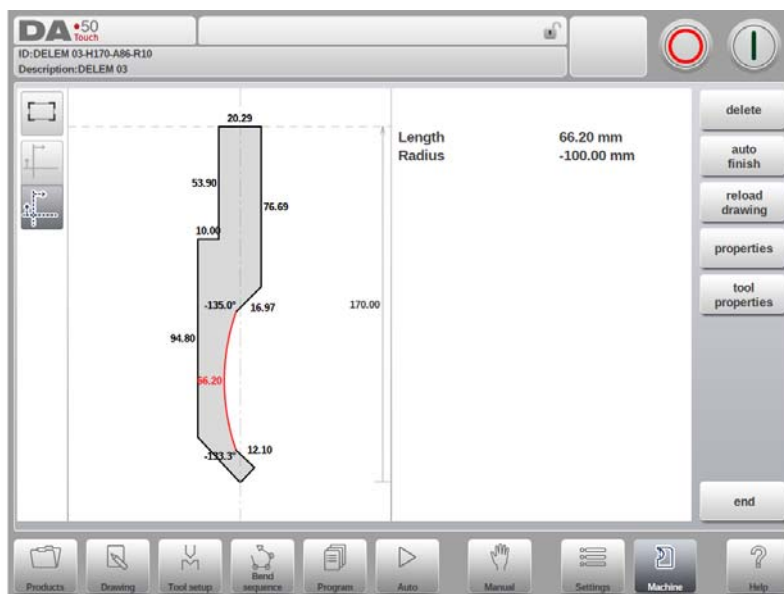

- Snapping will help to align lines and angles to its surroundings.

- A line has length as well as projection dimensions. These, along with its angle, can be used programming the desired line. The control will help in this by trying to accept your last input and adjusting the necessary values around. This is very helpful since drawings might alter in what dimension information is given at each shape detail.

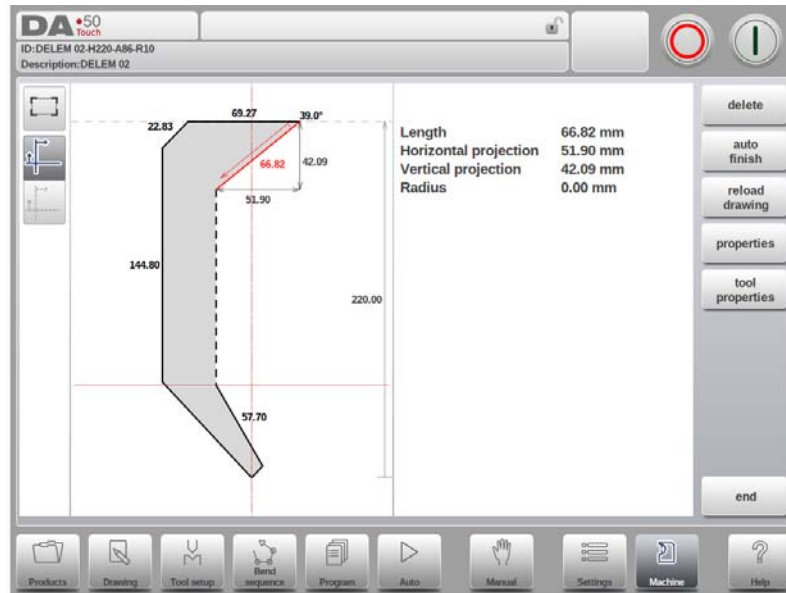

- Help lines are provided to measure inter point distances and also enable to change the point based on the desired distance. When selecting a point, help lines appear. When you move help lines to reference your desired value, just change the dimension and the point will move where you need it.

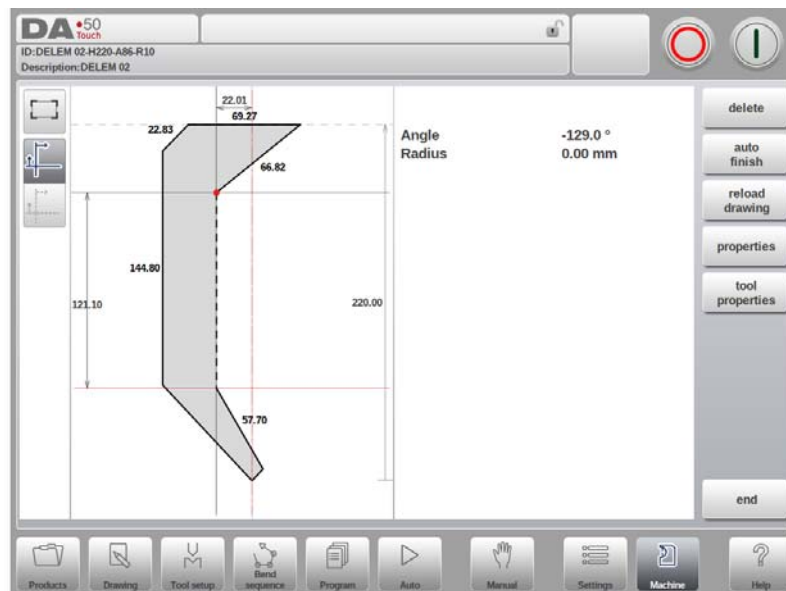

- 
- For your convenience the help lines can be switched off, giving a non disturbed view to what you have drawn.



## 10.6. Maintenance

On this tab maintenance related functions are located. Next to the machine hour counter and the machine stroke counter also functions to help replace modules and to store diagnostic data can be found here.

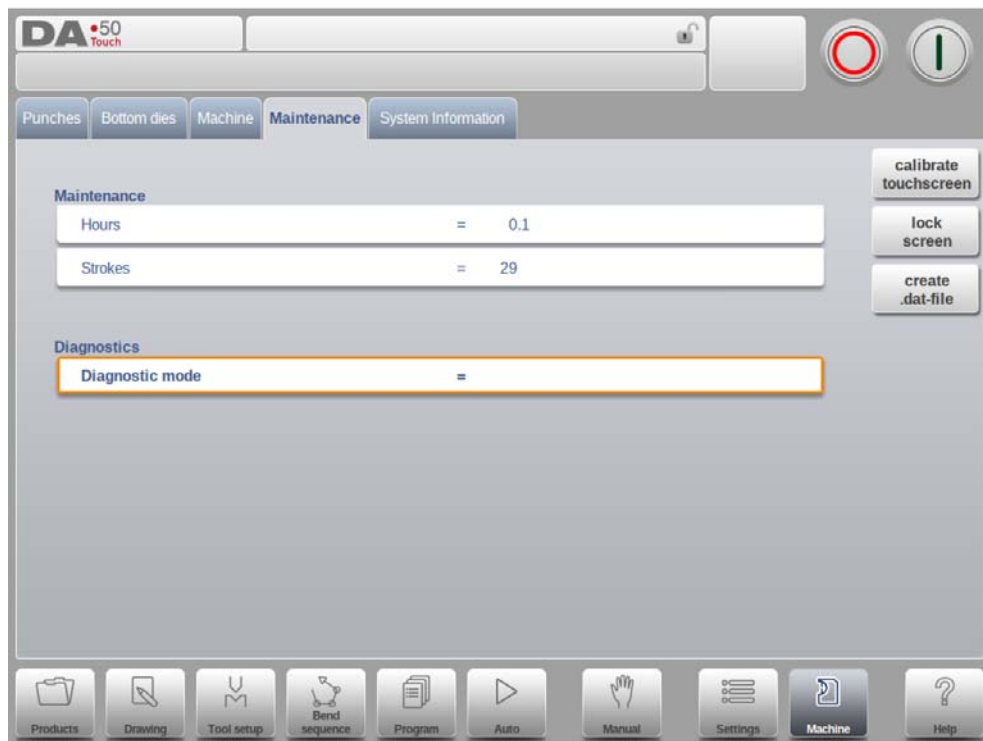

### Hours

The number of hours the machine is running.

### Strokes

The number of strokes the pressbeam has executed.

### Diagnostic mode

Activate or de-activate a diagnostic mode for service purposes. The diagnostic mode is activated by programming a special code here. The diagnostic mode is de-activated by programming 0.

To activate the diagnostic mode, contact the machine manufacturer for more information about this mode and an access code.

### Calibrate touchscreen

Calibration function to adjust the screen calibration to the users preference.

### Lock screen

To lock the screen, and e.g. clean the screen without changing anything, the Lock Screen function can be used. The screen is unlocked automatically after 10 seconds.

### Create .dat-file

---

When the cursor is placed on Diagnostic mode an additional function will appear. Tapping Create .dat-file will store the most important product and control data on the connected USB stick. This information can be helpful for the maintenance support.

## 10.7. System information

On this tab system information can be found. Next to version information on the software also ID's of the installed modules and version of OEM-specific files can be read.

Next to information also software update functionality is available here.



This screen shows detailed information about the control system. This information is useful for service purposes.

### Application

The version of the current application

### Option ID

The unique option ID of the control

### Sequencer

The version number of the running sequencer

### Delem.def

The version number of the running delem.def file

---

**Update software**

With Update Software the control can install a software update set from a USB stick. The directory browser will help to select the desired update and initiate the installation process.

**Backup system**

The backup system function makes a complete system backup to a USB stick. A unique timestamped file is written on the USB stick. This backup holds Delem software, OEM specific data as well as the user's files.

**Restore system**

The restore system function can be used to restore an earlier made backup of the system. During the process selection of what will be restored can be done.

**Offline software**

The offline software function generates an offline software setup file on a USB stick. This setup can be used to update an existing offline software. Using the matching offline software version with the control software ensures optimal compatibility of functions.

## A. Parameter index

This appendix contains a list of all parameters described in this manual, in alphabetic order.

90 Degree tolerance	5.12	Default wait for retract	9.14
Active bend allowance table	9.16	deflect	7.3
Adjust decompression	10.20	deflect	7.3
Angle	10.4	Delay time	6.12
Angle	10.9	Delem.def	10.31
Angle	3.10	Depth	7.3
Angle	6.8	Description	10.16
Angle	7.3	Description	10.6
Angle	8.2	Diagnostic mode	10.29
Angle 1 / Angle 2	7.2	Die	6.6
Angle correction database	9.11	Die	8.5
Angle correction programming	9.12	Dimensions	3.2
Angle selection	6.4	Display time	9.22
Application	10.31	Dwell time	6.12
Auto bend change mode step	9.18	Dwell time	8.4
Auto computations edit	9.12	E module	9.4
Auxiliary axis	6.8	Edge tolerance	5.12
Auxiliary axis	7.2	Equal bumping-segments	3.12
Auxiliary axis	8.5	Finger height (FH)	10.25
Axis speeds	6.8	Finger length (FL)	10.25
Backstop against sharp angle allowed	5.11	Finger width	10.23
Backstop-die, intermediate bend	5.11	Force	6.12
Bend allowance	3.3	Force	8.3
Bend position	6.8	Front extend ratio	5.10
Bend type	3.10	Front extend ratio accept	5.10
Bending length	3.2	Gauge height (H1/H3/H4)	10.25
Bending length	6.8	Gauge height (H2)	10.25
Bending length	8.2	Gauge length (L1)	10.25
Blank length	6.4	Gauge length (L2/L3)	10.25
Bottoming force factor	9.17	Gauge positions	10.22
Boundary 1/2/3	9.21	Gauge R offset	10.22
Central angle	3.12	General angle correction programming	9.12
Clamping correction	9.19	Height	10.11
Command panel side	9.3	Height	10.14
Computed radius	3.10	Height	10.18
Corr.α 1, Corr.α 2	8.2	Height	10.19
Corr.Y	8.2	Height	10.21
Data preparation bend allowance	9.16	Height	10.4
Date format	9.22	Height	10.8
Decomp speed	8.4	Height	10.9
Decompression	6.12	Help language	9.2
Decompression	8.4	Hem opening	3.14
Decompression speed	6.12	Hem opening	6.8
Default delay time	9.14	Hem opening	8.3
Default dimensions	9.15	Hemming height	10.9
Default dwell time	9.15	Hemming load opening	10.20
Default hem opening	9.15	Hemming load opening	10.8
Default lay on position	10.22	Hemming load opening	10.9
Default prebend angle	9.15	Hemming resistance	10.10
Default pressing speed	9.14	Hemming resistance	10.18
Default step change code	9.14	Hemming resistance	10.20
		Hemming resistance	10.21
		Hemming resistance	10.8
		Hemming width	10.18
		Hemming width	10.21
		Hemming width	10.8
		Hemming width	10.9
		Horizontal projection	3.7

Hours	10.29	Radius factor	5.10
ID	10.13	Radius height	10.11
ID	10.3	Repetition	6.12
Inch/mm-select	9.2	Repetition	7.3
Initial angle correction	9.12	Resistance	10.11
Inside hemming die type	10.20	Resistance	10.15
Intermediate R for X-movement	9.19	Resistance	10.16
Intermediate X for Z-movement	9.19	Resistance	10.19
Key sound	9.3	Resistance	10.21
Keyboard layout	9.3	Resistance	10.4
Language	9.2	Resistance	10.6
Lay-on	6.9	Resistance	10.9
Lay-on backstop limit	5.12	Resistance per m/mm selection	9.2
Lock touch screen when started	9.19	Retract	6.8
Lower hemming width	10.20	Retract	8.5
Lower part height	10.20	Sequencer	10.31
Lower part width	10.20	Shape	10.13
Machine description	9.13	Shape	10.3
Machine ID	9.13	Side length	3.14
Manual mode store angle corrections	9.12	Speed	8.4
Material	3.2	Speed	8.6
Material	6.4	Step change code	6.12
Material	8.4	Step mode	7.3
Material name	9.4	Stock	7.3
Method	6.7	Stock count mode	9.18
Method	8.2	Strokes	10.29
Minimum Y opening	5.11	Support type	10.6
Mute	10.17	Tensile strength	9.4
Mute	6.11	Thickness	3.2
Mute	8.2	Thickness	6.4
Number of segments	3.12	Thickness	8.4
Opening	6.8	Time format	9.22
Opening	8.3	Ton/kN select	9.2
Optimisation degree	5.10	Top width	10.11
Option ID	10.31	U height	10.21
Parallel	8.3	U opening	10.21
Parallelism	6.11	Upper hemming width	10.20
Parallelism offset	9.18	Upper part width	10.19
Prebend angle	3.13	V angle	10.14
Precision	3.8	V angle	10.19
Preferred Radius	3.10	V bottom	10.15
Pressing speed	6.12	V bottom	10.19
Pressure correction	9.19	V opening	10.14
Product description	3.2	V opening	10.19
Product description	6.4	Vertical projection	3.7
Product ID	3.2	Wait for retract	6.12
Product ID	6.4	Wait for retract	8.4
Punch	6.6	Width	10.14
Punch	8.5	Width	10.21
R	6.9	Width	10.4
Radius	10.11	Width	10.9
Radius	10.14	X	6.9
Radius	10.19	X position correction	10.23
Radius	10.21	X-axes	7.3
Radius	10.4	X-safety offset	10.17
Radius	10.9	Y opening default	9.14
Radius	3.12	Y1 / Y2	7.2
Radius	3.3	Y1Y2 independent	9.13

Y-axis .....8.2  
Z-distance .....9.17

---